



lifestyle
WD

CATALOGO
2024



IT Una linea di utensili ed oggetti per la casa, la cucina ed il tempo libero, concepita in maniera innovativa e cosmopolita, con occhio sempre attento ai nuovi trends in termini di design e materiali.

Lo stile giovane, colorato e contemporaneo rimane saldo e presente all'interno di questo catalogo. Per la realizzazione dei nostri prodotti utilizziamo, dove possibile, materiali riciclati; i fornitori dei nostri packaging sono da noi sempre più sensibilizzati all'utilizzo di carta e cartone certificati FSC, ovvero provenienti da foreste gestite in maniera corretta e responsabile secondo rigorosi standard ambientali, sociali ed economici.

EN A line of items and kitchen objects that has been developed in a very innovative and cosmopolitan way, with an eye towards new trends in terms of design and materials.

The young, colorful and contemporary style remains firm and present in this catalogue. For the realization of our products, where possible, we use recycled materials; our packaging suppliers are increasingly sensitized to the use of FSC-certified paper and cardboard, namely coming from forests managed in a correct and responsible manner according to strict environmental, social and economic standards.

FR Une ligne d'ustensiles et d'objets pour la maison, la cuisine et les loisirs, conçue de manière innovante et cosmopolite, avec un oeil toujours attentif aux nouvelles tendances en termes de design et de matériaux.

Le style jeune, coloré et contemporain reste solide et présent dans ce catalogue. Pour la réalisation de nos produits, nous utilisons, dans la mesure du possible, des matériaux recyclés; ensuite, nous encourageons de plus en plus nos fournisseurs d'emballages à utiliser du papier et de carton certifiés FSC, ou provenant de forêts gérées de manière correcte et responsable selon des normes environnementales, sociales et économiques strictes.

Uno speciale ringraziamento per la location a/Special thanks for the location to:

nif: alpine taste, Martinelli ceramiche, Ristorante Pizzeria al Faro, Locanda del Gatto Gordo



Nif: alpine taste



martinelliceramiche.it



@ristorante_pizzeria_al_faro



@nif_alpinetaste



@martinelliceramichesrl



@locandadelgattogordo

pag. 218 - Foto di Nicola Mettifogo realizzate per conto di Casapiù Strapparava Snc (@strapparavahomedcor)

pag. 252 - Foto di proprietà di Ambra Orazi (<https://www.ilgattoghiotto.it/>)

BALAT LINE



WD736

IT Alzatina in vetro colorata.

Caratterizzata da forme irregolari e colori brillanti, dona colore ed unicità alla tua tavola. Colore: Arancione e Verde. Diametro: 18 cm.

EN Elevated colored glass cakestand. Characterized by irregular shapes and bright colors, it adds color and uniqueness to your table. Color: Orange et Vert. Diameter: 18 cm.

FR Plateau surélevé en verre coloré. Caractérisé par des formes irrégulières et des couleurs vives, il ajoute de la couleur et de l'unicité à votre table. Couleurs: Orange et Vert. Diamètre: 18 cm.



WD736AR



 No microonde
Nomicrowave
Pas de micro-ondes

 No lavastoviglie
No dishwasher
Pas de lave-vaisselle



WD737

IT Alzata in vetro colorata.

Caratterizzata da forme irregolari e colori brillanti, dona colore ed unicità alla tua tavola. Colore: Borgogna e Navy. Diametro: 21 cm.

EN Colored glass cakestand. Characterized by irregular shapes and bright colors, it adds color and uniqueness to your table. Color: Burgundy and Navy. Diameter: 21 cm.

FR Plateau surélevé en verre coloré. Caractérisé par des formes irrégulières et des couleurs vives, il ajoute de la couleur et de l'unicité à votre table. Couleurs: Bourgogne et bleu marine. Diamètre: 21 cm



WD737BO

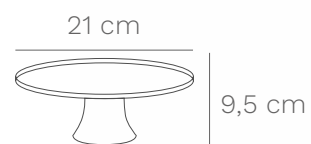

No microonde
Nomicrowave
Pas de micro-ondes

No lavastoviglie
No dishwasher
Pas de lave-vaisselle

WD738

IT Alzata in vetro colorata.

Caratterizzata da forme irregolari e colori brillanti, dona colore ed unicità alla tua tavola. Colore: Lilla e Turchese. Diametro: 28 cm.

EN Colored glass cakestand. Characterized by irregular shapes and bright colors, it adds color and uniqueness to your table. Color: Lilac and Turquoise. Diameter: 28 cm.

FR Plateau surélevé en verre coloré. Caractérisé par des formes irrégulières et des couleurs vives, il ajoute de la couleur et de l'unicité à votre table. Couleurs: Lilas et Turquoise. Diamètre: 28 cm.



WD738LI



No microonde
Nomicrowave
Pas de micro-ondes

No lavastoviglie
No dishwasher
Pas de lave-vaisselle

WD739

IT Insalatiera in vetro colorata.

Dalla forma irregolare dona alla tua tavola unicità e colore. Capacità 1,7L.

EN Colored glass salad bowl. With its irregular shape, it gives your table uniqueness and color. 1,7L capacity.

FR Saladier en verre coloré. Avec sa forme irrégulière, il donne à votre table de l'unicité et de la couleur. Contenance de 1,7L.



WD739AR



No microonde
Nomicrowave
Pas de micro-ondes



No lavastoviglie
No dishwasher
Pas de lave-vaisselle

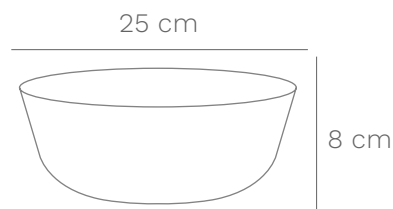

WD740

IT Set 2 coppette in vetro colorate.

Servi le tue preparazioni dolci e salate con colore e stile, rendendo la tua tavola colorata ed originale. Capacità 300 ml. Disponibili in 3 varianti colori: Borgogna e Navy, Lilla e Turchese, Arancio e Verde.

EN Set of 2 colored glass bowls. Serve your sweet and savory preparations with color and style, making your table colorful and original. 300 ml capacity. Available in 3 color variants: Burgundy and Navy, Lilac and Turquoise, Orange and Green.

FR Set de 2 bols en verre coloré. Servez vos préparations sucrées et salées avec couleur et style, rendant votre table colorée et originale. Contenance de 300 ml. Disponibles en 3 variantes de couleurs: Bourgogne et bleu marine, Lilas et Turquoise, Orange et Vert.



WD740BO

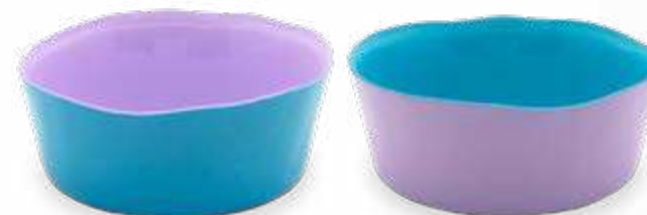

WD740T



WD740V

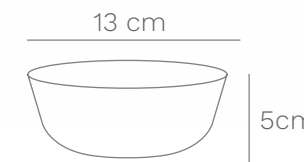

No microonde
Nomicrowave
Pas de micro-ondes



No lavastoviglie
No dishwasher
Pas de lave-vaisselle

WD741

IT Set 2 ciotole in vetro colorate.

Adatti per servire le tue preparazioni calde o fredde, dolci o salate con colore e stile, rendendo la tua tavola colorata ed originale. Capacità 500 ml. Disponibili in 3 varianti colore: Borgogna e Turchese, Arancio e Navy, Lilla e Verde

EN Set of 2 colored glass bowls. Suitable for serving your hot or cold, sweet or savory preparations with color and style, making your table colorful and original. 500 ml capacity. Available in 3 color variants: Burgundy and Turquoise, Orange and Navy, Lilac and Green.

FR Set de 2 bols en verre coloré. Idéaux pour servir vos préparations chaudes ou froides, sucrées ou salées avec couleur et style, rendant votre table colorée et originale. Capacité de 500 ml. Disponibles en 3 variantes de couleurs: Bourgogne et Turquoise, Orange et bleu marine, Lilas et Vert.



No microonde
Nomicrowave
Pas de micro-ondes



No lavastoviglie
No dishwasher
Pas de lave-vaisselle

15,5 cm

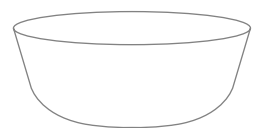

6 cm



WD741AR



WD741BO



WD741LI



WD742

IT Set 2 piattini in vetro colorati.

Adatti per servire le tue preparazioni in maniera originale, donando colore e unicità alla tua tavola. Disponibili in 3 varianti colore: Arancio e Verde, Lilla e Turchese, Borgogna e Navy.

EN Set of 2 colored glass plates. Suitable for serving your creations in an original way, adding color and uniqueness to your table. Available in 3 color variations: Orange and Green, Lilac and Turquoise, Burgundy and Navy.

FR Set de 2 assiettes en verre coloré. Idéal pour servir vos créations de manière originale, ajoutant de la couleur et de l'unicité à votre table. Disponible en 3 variantes de couleurs: Orange et Vert, Lilas et Turquoise, Bourgogne et Bleu marine.



WD741AR

WD742BO



WD742LI

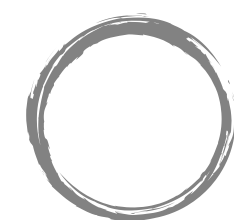

18 cm

 No microonde
Nomicrowave
Pas de micro-ondes

 No lavastoviglie
No dishwasher
Pas de lave-vaisselle

WD743

IT Set 2 piatti in vetro colorati.

Adatti per servire le tue preparazioni in maniera originale, donando colore e unicità alla tua tavola. Disponibili in 3 varianti colore: Borgogna e Turchese, Lilla e Verde, Arancio e Navy.

EN Set of 2 colored glass plates. Suitable for serving your creations in an original way, adding color and uniqueness to your table. Available in 3 color variations: Burgundy and Turquoise, Lilac and Green, Orange and Navy.

FR Set de 2 assiettes en verre coloré. Idéal pour servir vos créations de manière originale, ajoutant de la couleur et de l'unicité à votre table. Disponible en 3 variations de couleurs: Bourgogne et Turquoise, Lilas et Vert, Orange et bleu marine.



WD743AR



WD743LI



WD743T

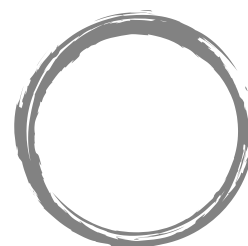

21 cm

No microonde
Nomicrowave
Pas de micro-ondes

No lavastoviglie
No dishwasher
Pas de lave-vaisselle



WD744

IT Piatto piano in vetro colorato.

Dona colore ed eleganza alla tua tavola, rendendola unica ed originale grazie alle forme irregolari che lo caratterizzano. Perfetto anche come piatto a servire o centrotavola. Disponibile in 3 varianti colore: Arancio e Navy, Borgogna e Turchese, Lilla e Verde.

EN Flat plate in colored glass. Adds color and elegance to your table, making it unique and original thanks to its irregular shapes. Perfect also as a serving plate or centerpiece. Available in 3 color variations: Orange and Navy, Burgundy and Turquoise, Lilac and Green.

FR Assiette plate en verre coloré. Ajoutez de la couleur et de l'élégance à votre table, la rendant unique et originale grâce à ses formes irrégulières. Parfait également en tant qu'assiette de service ou centre de table. Disponible en 3 variantes de couleurs: Orange et Marine, Bordeaux et Turquoise, Lilas et Vert.



WD744AR



WD744LI



WD744BO

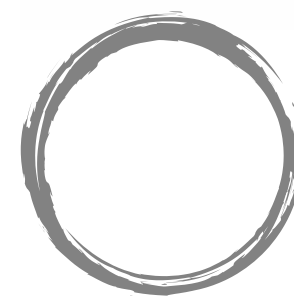

28 cm

No microonde
Nomicrowave
Pas de micro-ondes

No lavastoviglie
No dishwasher
Pas de lave-vaisselle



LINEA TOKYO



WD720

IT Neon decorativo per illuminare ogni ambiente della tua casa con uno stile originale ed iconico.

Dimensioni: 23 x 4 x 12,7 cm. Presa USB-A e interruttore ON/OFF inclusi. Input: 5.0V 1A (USB). Potenza: 5W. Disponibile in 4 versioni: Happy, Dream, Cheers, Love.

EN Decorative neon to illuminate every room in your home with an original and iconic style. Dimensions: 23 x 4 x 12,7 cm USB-A socket and ON/OFF switch included. Input: 5.0V 1A (USB). Power: 5W. Available in 4 versions: Happy, Dream, Cheers, Love.

FR Néon décoratif pour illuminer chaque pièce de votre maison avec un style original et emblématique. Dimensions: 23 x 4 x 12,7 cm. Port USB-A et interrupteur ON/OFF inclus. Entrée: 5.0V 1A (USB). Puissance: 5W. Disponible en 4 versions: Happy, Dream, Cheers, Love.



WD720CHE



WD720DRE



WD720HAP



WD720LOV

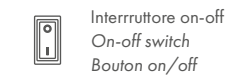
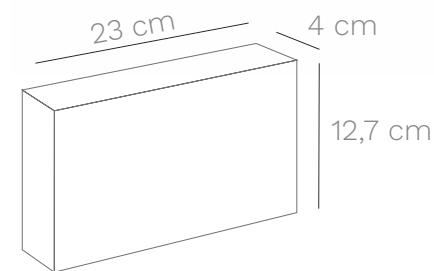

LINEA MYKONOS



WD721

IT Tovaglietta double-face. Con sfondo colorato e stampa collage.

Il retro in grigio tinta unita colore grigio. Ideale per le tue mise en place, donano colore ed allegria alla tua tavola. Materiale: PVC. Dimensioni 45,6 x 35,7 x 0,2 cm. Decor: alligatore, aragosta, polipo, delfino, tartaruga, rana.

EN Double-sided placemat with a colored background and collage print. Solid gray on the back. Ideal for your table settings, they add color and cheerfulness to your table. Material: PVC. Dimensions 45.6 x 35.7 x 0.2 cm. Designs: alligator, lobster, octopus, dolphin, turtle, frog.

FR Set de table réversible avec un fond coloré et une impression de collage sur le recto; gris uni sur le verso. Idéal pour vos mises en place, ils ajoutent de la couleur et de la gaieté à votre table. Matériau: PVC. Dimensions 45,6 x 35,7 x 0,2 cm. Motifs: alligator, homard, pieuvre, dauphin, tortue, grenouille.



WD721ARA



WD721POL

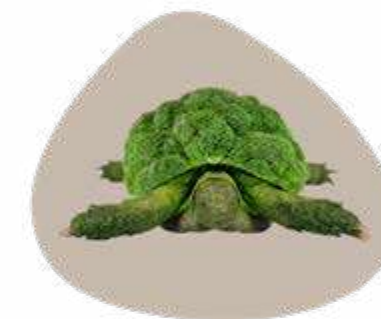

WD721TAR



WD721ALL



WD721RAN



WD721DEL

 Lavare con un panno umido
Wash with a damp cloth
Laver avec un chiffon humide



← *Retro in tinta unita*
The back in solid color
Uni sur le verso

WD691

IT Vassoio con fondo colorato e stampa collage.

Perfetto sia come vassoio sia come articolo decorativo, dai colori accesi e i decori simpatici donerà colore ed allegria alla tua cucina e alla tua casa. Il materiale in polipropilene ne permette una lunga durata ed una facile pulizia. Dimensione: Ø 33 cm H 2,2 cm. Disponibile in 2 decori: pappagallo e pavone.

EN Tray with coloured background and a collage print. Perfect both as a tray and as a decorative item; with its bright colours and cute decorations it will bring colour and cheer to your kitchen and home. The polypropylene material makes it long-lasting and easy to clean. Size: Ø 33 H 2.2 cm. Available in two decorations: parot and peacock.

FR Plateau avec fond coloré et impression d'un collage. Parfait à la fois comme plateau et comme objet de décoration, avec ses couleurs vives et ses jolies décorations, il apportera de la couleur et de la gaieté à votre cuisine et à votre maison. Le matériau en polypropylène le rend durable et facile à nettoyer. Taille: Ø 33 H 2,2 cm. Disponible en deux décorations: parot et paon.



WD691PAPPA



WD691PAV



33 cm

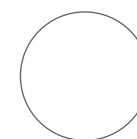

Lavare con un panno umido
Wash with a damp cloth
Laver avec un chiffon humide

WD692

IT Vassoio con fondo colorato e stampa collage.

Perfetto sia come vassoio sia come articolo decorativo, dai colori accesi e i decori simpatici donerà colore ed allegria alla tua cucina e alla tua casa. Il materiale in polipropilene ne permette una lunga durata ed una facile pulizia. Dimensione: L 40 I 24 H 2,55 cm. Disponibile in 2 decori: cigno e papera.

EN Tray with coloured background and a collage print. Perfect both as a tray and as a decorative item; with its bright colours and cute decorations it will bring colour and cheer to your kitchen and home. The polypropylene material makes it long-lasting and easy to clean. Size: W 40 I 24 H 2.55 cm. Available in two decorations: swan and duck.

FR Plateau avec fond coloré et impression d'un collage. Parfait à la fois comme plateau et comme objet de décoration, avec ses couleurs vives et ses jolies décorations, il apportera de la couleur et de la gaieté à votre cuisine et à votre maison. Le matériau en polypropylène le rend durable et facile à nettoyer. Taille: L 40 I 24 H 2,55 cm. Disponible en deux décorations: cygne et canard.



WD692CIG



WD692PAP



40 cm



24 cm



WD693

IT Vassoio con fondo colorato e stampa collage.

Perfetto sia come vassoio sia come articolo decorativo, dai colori accesi e i decori simpatici donerà colore ed allegria alla tua cucina e alla tua casa. Il materiale in polipropilene ne permette una lunga durata ed una facile pulizia. Dimensione: L 34 I 34 H 2,72 cm. Disponibile in 2 decori: paguro e cane.

EN Tray with coloured background and a collage print. Perfect both as a tray and as a decorative item; with its bright colours and cute decorations it will bring colour and cheer to your kitchen and home. The polypropylene material makes it long-lasting and easy to clean. Size: W 34 I 34 H 2.72 cm. Available in two decorations: hermit crab and dog.

FR Plateau avec fond coloré et impression d'un collage. Parfait à la fois comme plateau et comme objet de décoration, avec ses couleurs vives et ses jolies décorations, il apportera de la couleur et de la gaieté à votre cuisine et à votre maison. Le matériau en polypropylène le rend durable et facile à nettoyer. Taille: L 34 I 34 H 2.72 cm. Disponible en deux décorations: bernard-l'ermite et chien.



WD693PAG



WD693CAN



34 cm

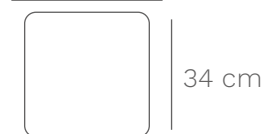

34 cm



WD694

IT Vassoio svuotatasche con fondo colorato e stampa collage.

Perfetto sia come vassoio sia come articolo decorativo, dai colori accesi e i decori simpatici donerà colore ed allegria alla tua cucina e alla tua casa. Il materiale in polipropilene ne permette una lunga durata ed una facile pulizia. Dimensione: L 28 l 17 H 0,95 cm. Disponibile in 2 decori: fenicottero e gallina.

EN Emptying tray with coloured background and a collage print. Perfect both as a tray and as a decorative item, its bright colours and cute decorations will bring colour and cheer to your kitchen and home. The polypropylene material makes it long-lasting and easy to clean. Dimensions: W 28 l 17 H 0.95 cm. Available in two decorations: flamingo and hen.

FR Plateau vide-poches avec fond coloré et impression d'un collage. Parfait à la fois comme plateau et comme objet de décoration, ses couleurs vives et ses jolies décorations apporteront de la couleur et de la gaieté à votre cuisine et à votre maison. Le matériau en polypropylène le rend durable et facile à nettoyer. Dimensions: L 28 l 17 H 0,95 cm. Disponible en deux décorations: flamant rose et poule.



WD694FEN



WD694GAL



28 cm

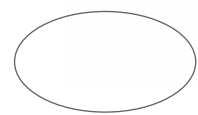

17 cm



Lavare con un panno umido
Wash with a damp cloth
Laver avec un chiffon humide



LINEA SAMARCANDA



WD722 *New*

IT Set 2 calici da cocktail in vetro.

Dalla forma moderna e dai colori brillanti donano colore alla tua tavola e rendono i tuoi drink ancora più invitanti. Capacità: 450 ml. Disponibile in 2 varianti: verde e bianco, rosa e viola; fucsia e azzurro, giallo e petrolio.

EN Set of 2 glass cocktail glasses. With a modern shape and bright colors, they add color to your table and make your drinks even more inviting. Capacity: 450 ml. Available in 2 variations: green and white, pink and purple; fuchsia and blue, yellow and petrol.

FR Set de 2 verres à cocktail en verre. Avec une forme moderne et des couleurs vives, ils ajoutent de la couleur à votre table et rendent vos boissons encore plus invitantes. Contenance: 450 ml. Disponible en 2 variantes: vert et blanc, rose et violet; fuchsia et bleu, jaune et pétrole.



WD722A

WD722B



No microonde
Nomicrowave
Pas de micro-ondes



No lavastoviglie
No dishwasher
Pas de lave-vaisselle

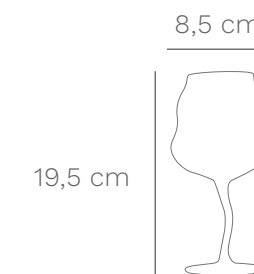
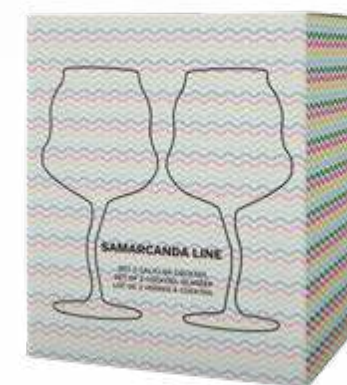

WD718 *New*

IT Lanterna in vetro con finiture in metallo.

Adatta ad ambienti classici e moderni, ideale per decorare la tua casa donando luce e calore. Candela non inclusa. Disponibile in 4 varianti di colore: rosa, bianco, verde, rosso.

EN Glass lantern with metal finishes. Suitable for both classic and modern environments, ideal for decorating your home by providing light and warmth. Candle not included. Available in 4 colors: pink, white, green, red.

FR Lanterne en verre avec finitions en métal. Adaptée aux environnements classiques et modernes, idéale pour décorer votre maison en apportant lumière et chaleur. Bougie non incluse. Disponible en 4 variantes de couleur: rose, blanc, vert, rouge.



WD718B



WD718R

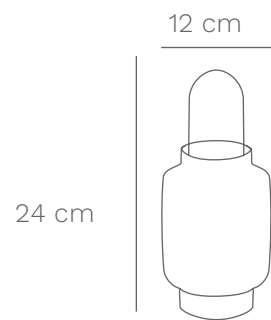

WD718RO



WD718V



WD719 *New*

IT Lanterna in vetro con finiture in metallo.

Adatta ad ambienti classici e moderni, ideale per decorare la tua casa donando luce e calore. Candela non inclusa. Disponibile in 4 varianti di colore: rosa, bianco, verde, rosso.

EN Glass lantern with metal finishes. Suitable for both classic and modern environments, ideal for decorating your home by providing light and warmth. Candle not included. Available in 4 colors: pink, white, green, red.

FR Lanterne en verre avec finitions en métal. Adaptée aux environnements classiques et modernes, idéale pour décorer votre maison en apportant lumière et chaleur. Bougie non incluse. Disponible en 4 variantes de couleur: rose, blanc, vert, rouge.



WD719B



WD719R

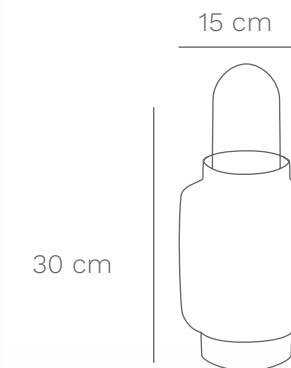

WD719RO



WD719V





WD682

IT Macinapepe in legno laccato certificato FSC con macina in ceramica.

Dimensione: Ø 5 H 21 cm. Disponibile in 4 varianti di colore: rosso, salvia, bianco e nero.

EN Lacquered wooden pepper mill with ceramic grinder. Dimensions: Ø 5 H 21 cm. Available in 4 colour variants: red, sage, white and black.

FR Moulin à poivre en bois laqué avec broyeur en céramique. Dimensions: Ø 5 H 21 cm. Disponible en 4 couleurs: rouge, sauge, blanc et noir.



WD682R

WD682SA

WD682B

WD682N

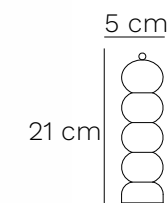

No lavastoviglie
No dishwasher
Pas de lave-vaisselle

WD683

IT Set macinapepe e sale in legno laccato certificato FSC con macina in ceramica.

La combo perfetta: compatti, funzionali e dai colori brillanti che permetteranno a te ed ai tuoi ospiti di regolare il dosaggio e decidere il grado di macinatura perfetto. Dimensione: Ø 5 H 11,5 cm. Disponibile in 2 varianti: corallo/celeste e grigio/crema.

EN Lacquered wooden pepper and salt mill set with ceramic grinder. The perfect combo: they are compact, functional and have bright colours that will allow you and your guests to adjust the dosage and decide on the perfect level of grinding. Size: Ø 5 H 11.5 cm. Available in 2 variants: coral/celeste and grey/cream.

FR Set de moulins à poivre et à sel en bois laqué avec broyeur en céramique. La combinaison parfaite: compactes, fonctionnelles et avec des couleurs vives qui vous permettront, à vous et à vos invités, d'ajuster le dosage et de décider du degré de broyage parfait. Dimensions: Ø 5 H 11,5 cm. Disponible en 2 variantes: corail/céleste et gris/creme. en 4 couleurs: rouge, sauge, blanc et noir.



WD683A



WD683B

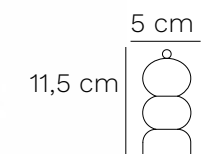

WD711

IT Sgabello in ceramica con finitura lucida.

Un articolo d'arredo che ti permetterà di donare luce ed originalità alla tua casa, perfetto sia come seduta sia come tavolino. Dimensione: Ø 33 H 42,5 cm. Disponibile in 4 varianti di colore: rosso, crema, antracite, verde.

EN Ceramic stool with a polished finish. A piece of furniture that will allow you to add light and originality to your home, perfect both as a seat and as a coffee table. Dimensions: Ø 33 H 42,5 cm. Available in 4 colours: red, cream, anthracite, green.

FR Tabouret en céramique avec une finition polie. Un meuble qui vous permettra d'apporter de la lumière et de l'originalité à votre intérieur, parfait aussi bien comme siège que comme table basse. Dimensions: Ø 33 H 42,5 cm. Disponible en 4 couleurs: rouge, crème, anthracite, vert.



WD711R



WD711CR



WD711AN



WD711V

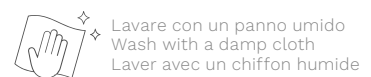
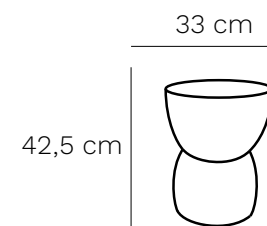



WD686CE



WD686GI



WD686TR



WD686R

WD686

IT Portacandele in vetro borosilicato.

Si adatta perfettamente ad ambienti classici e moderni; ideale per decorare in maniera originale la tua tavola e la tua casa. Può essere utilizzato anche come portafiori o centrotavola. Candela non inclusa. Confezionata in scatola regalo FSC. Dimensione: Ø 8,5 H 12 cm. Disponibile in 4 varianti di colore: celeste, giallo, trasparente, rosso.

EN Borosilicate glass candle holder. It fits perfectly in classic and modern environments; ideal for decorating your table and home in an original way. It can also be used as a flower holder or centrepiece. Candle not included. Packaged in FSC gift box. Size: Ø 8.5 H 12 cm. Available in 4 colour variants: light blue, yellow, transparent, red.

FR Bougeoir en verre borosilicate. Il s'intègre parfaitement dans les environnements classiques et modernes; idéal pour décorer votre table et votre maison de manière originale. Il peut également être utilisé comme porte-fleurs ou centre de table. Bougie non incluse. Emballé dans une boîte cadeau FSC. Taille: Ø 8,5 H 12 cm. Disponible en 4 variantes de couleurs: bleu clair, jaune, transparent, rouge.

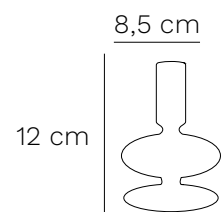

Lavare con un panno umido
Wash with a damp cloth
Laver avec un chiffon humide



WD687

IT Portacandele in vetro borosilicato.

Si adatta perfettamente ad ambienti classici e moderni; ideale per decorare in maniera originale la tua tavola e la tua casa. Può essere utilizzato anche come portafiori o centrotavola. Candela non inclusa. Confezionata in scatola regalo FSC. Dimensione: Ø 8,5 H 16 cm. Disponibile in 4 varianti di colore: trasparente, rosa, petrolio, rosso.

EN Borosilicate glass candle holder. It fits perfectly in classic and modern environments; ideal for decorating your table and home in an original way. It can also be used as a flower holder or centrepiece. Candle not included. Packaged in FSC gift box. Size: Ø 8,5 H 16 cm. Available in 4 colour variants: transparent, pink, petrol, red.

FR Bougeoir en verre borosilicate. Il s'intègre parfaitement dans les environnements classiques et modernes; idéal pour décorer votre table et votre maison de manière originale. Il peut également être utilisé comme porte-fleurs ou centre de table. Bougie non incluse. Emballé dans une boîte cadeau FSC. Taille: Ø 8,5 H 16 cm. Disponible en 4 variantes de couleurs: transparent, rose, essence, rouge.



WD687TR



WD687RO



WD687PET



WD687R

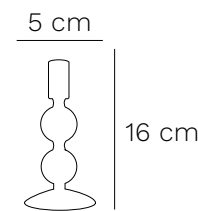

Lavare con un panno umido
Wash with a damp cloth
Laver avec un chiffon humide





WD688TR

WD688V

WD688BL

WD688R

WD688

IT Portacandele in vetro borosilicato.

Si adatta perfettamente ad ambienti classici e moderni; ideale per decorare in maniera originale la tua tavola e la tua casa. Può essere utilizzato anche come portafiori o centrotavola. Candela non inclusa. Confezionata in scatola regalo FSC. Dimensione: Ø 8,5 H 20 cm. Disponibile in 4 varianti di colore: trasparente, verde, blu, rosso.

EN Borosilicate glass candle holder. It fits perfectly in classic and modern environments; ideal for decorating your table and home in an original way. It can also be used as a flower holder or centrepiece. Candle not included. Packaged in FSC gift box. Size: Ø 8,5 H 20 cm. Available in 4 colour variants: transparent, green, blue, red.

FR Bougeoir en verre borosilicate. Il s'intègre parfaitement dans les environnements classiques et modernes; idéal pour décorer votre table et votre maison de manière originale. Il peut également être utilisé comme porte-fleurs ou centre de table. Bougie non incluse. Emballé dans une boîte cadeau FSC. Taille: Ø 8,5 H 20 cm. Disponible en 4 variantes de couleurs: transparent, vert, bleu, rouge.

8,5 cm

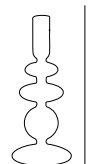

20 cm



Lavare con un panno umido
Wash with a damp cloth
Laver avec un chiffon humide



WD689

IT Portacandele in vetro borosilicato.

Si adatta perfettamente ad ambienti classici e moderni; ideale per decorare in maniera originale la tua tavola e la tua casa. Può essere utilizzato anche come portafiori o centrotavola. Candela non inclusa. Confezionata in scatola regalo FSC. Dimensione: Ø 8,5 H 25 cm. Disponibile in 4 varianti di colore: rosso, lilla, trasparente, pesca.

EN Borosilicate glass candle holder. It fits perfectly in classic and modern environments; ideal for decorating your table and home in an original way. It can also be used as a flower holder or centrepiece. Candle not included. Packaged in FSC gift box. Size: Ø 8,5 H 25 cm. Available in 4 colour variants: red, lilac, transparent, peach.

FR Bougeoir en verre borosilicate. Il s'intègre parfaitement dans les environnements classiques et modernes; idéal pour décorer votre table et votre maison de manière originale. Il peut également être utilisé comme porte-fleurs ou centre de table. Bougie non incluse. Emballé dans une boîte cadeau FSC. Taille: Ø 8,5 H 20 cm. Disponible en 4 variantes de couleurs: rouge, lilas, transparent, pêche.



WD689R



WD689LI



WD689TR



WD689PE

8,5 cm

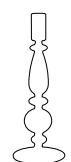

25 cm



Lavare con un panno umido
Wash with a damp cloth
Laver avec un chiffon humide

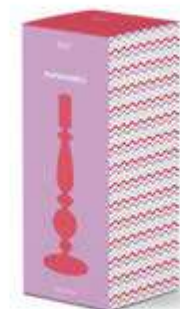

WD690TR



WD690LI



WD690V



WD690R

WD690

IT Porta tealight in vetro borosilicato.

Oggetto originale e colorato perfetto per rendere l'atmosfera in casa più accogliente e romantica. Perfetto anche come centrotavola decorativo. Tealight non inclusa. Si consiglia di utilizzare candele con rivestimento in alluminio. Confezionata in scatola regalo FSC. Dimensione: Ø 8,5 H 22 cm. Disponibile in 4 varianti di colore: trasparente, lilla, verde, rosso.

EN Borosilicate glass tealight holder. Original and colourful object perfect for making the atmosphere in the home more cosy and romantic. Also perfect as a decorative centrepiece. We recommend using aluminium-coated candles. Tealight not included. Packaged in FSC gift box. Size: Ø 8,5 H 22 cm Available in 4 colour variants: transparent, lilac, green, red.

FR Porte-bougies à réchaud en verre borosilicate. Objet original et coloré, parfait pour rendre l'atmosphère de la maison plus chaleureuse et romantique. Parfait également comme centre de table décoratif. Nous recommandons d'utiliser des bougies recouvertes d'aluminium. Bougie à réchaud non incluse. Emballé dans une boîte cadeau FSC. Taille: Ø 8,5 H 22 cm. Disponible en 4 couleurs: transparent, lilas, vert, rouge.

8,5 cm



22 cm



Lavare con un panno umido
Wash with a damp cloth
Laver avec un chiffon humide



MONTEREY LINE



WD716 *New*

IT Zuccheriera in vetro borosilicato con cucchiaino e decori in vetro colorato.

Ogni soggetto è realizzato artigianalmente in vetro soffiato rendendo ogni singolo articolo un pezzo unico.

Capacità 300 ml. Decor: Ape e Margherita; Coniglio e Carota.

EN Sugar bowl in borosilicate glass with teaspoon and decorations in colored glass. Each subject is handcrafted in blown glass making every single item a unique piece. 300 ml capacity. Decorations: Bee and Daisy; Rabbit and Carrot

FR Sucrier en verre borosilicate avec cuillère et décor en verre coloré. Chaque sujet est fabriqué à la main en verre soufflé faisant de chaque article une pièce unique. Contenance 300 ml. Décors: Abeille et Marguerite; Lapin et Carotte



WD716APE



WD716CON



 Si lavastoviglie
Dishwasher safe
Lave-vaisselle possible

 Si microonde
Microwave safe
Micro-ondes possible

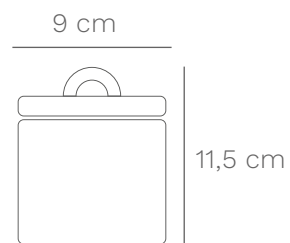

WD717 *New*

IT Set 2 tazzine in vetro borosilicato con manico colorato e decoro esterno in vetro colorato.

Ogni soggetto è realizzato artigianalmente in vetro soffiato rendendo ogni singolo articolo un pezzo unico. Capacità 130 ml. Soggetti: Libellula, Lumaca, Farfalla, Ape, Coccinella, Margherita

EN Set of 2 borosilicate glass cups with colored handle and external decoration in colored glass. Each design is handcrafted in blown glass, making each individual item a unique piece. 130 ml capacity. Subjects: Dragonfly, Snail, Butterfly, Bee, Ladybug, Daisy.

FR Set de 2 tasses à café en verre borosilicate avec poignée colorée et décoration extérieure en verre coloré. Chaque motif est fabriqué à la main en verre soufflé, ce qui rend chaque article unique. Capacité de 130 ml. Sujets: Libellule, Escargot, Papillon, Abeille, Coccinelle, Marguerite.



WD717APE



WD717COC



WD717FAR

5 cm

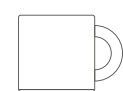

5 cm



Si lavastoviglie
Dishwasher safe
Lave-vaisselle possible



Si microonde
Microwave safe
Micro-ondes possible



WD717LIB



WD717LUM



WD717MAR

5 cm

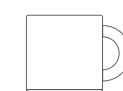

5 cm



Si lavastoviglie
Dishwasher safe
Lave-vaisselle possible



Si microonde
Microwave safe
Micro-ondes possible

WD695 *New*

IT Set 4 cucchiaini da caffè con decoro estivo realizzato artigianalmente in vetro soffiato colorato.

Un regalo originale che farà impazzire amici e familiari, abbinalo agli altri articoli della linea Monterey per un set completo! Dimensione: H 9,5 cm.

EN Set of 4 coffee spoons with summer decoration, handcrafted in coloured blown glass. An original gift that will delight friends and family, combine it with the other items in the Monterey line for a complete set! Size: H 9.5 cm.

FR Set de 4 cuillères à café avec décoration d'été, fabriquées artisanalement en verre soufflé coloré. Un cadeau original qui fera plaisir à vos amis et à votre famille. Combinez-le avec les autres articles de la ligne Monterey pour un ensemble complet! Taille: H 9,5 cm.



WD695AZZ

WD695ROS



9,5 cm



Si lavastoviglie
Dishwasher safe
Lave-vaisselle possible



Si microonde
Microwave safe
Micro-ondes possible



WD710

IT Diffusore di essenza in vetro borosilicato con decoro in vetro colorato all'esterno e due set di bastoncini in legno (colore naturale e nero).

Un oggetto che ti permette di rendere ogni ambiente particolare creando fragranze diverse a seconda dei tuoi gusti. Perfetto anche come regalo per amici e parenti. Oli essenziali non inclusi. Capacità: 230 ml. Dimensione: Ø 6 cm H 11,5 cm. Decorazioni: coccinella, cuore, farfalla.

EN Borosilicate glass essence diffuser with coloured glass decoration on the outside and two sets of wooden sticks (natural and black). An object that allows you to make every room special by creating different fragrances according to your taste. Also perfect as a gift for friends and family. Essential oils not included. Capacity: 230 ml. Size: Ø 6 cm H 11.5 cm. Decorations: ladybird, heart, butterfly.

FR Diffuseur d'essence en verre borosilicate avec décoration en verre coloré à l'extérieur et deux lots de bâtonnets en bois (naturel et noir). Un objet qui vous permet de rendre chaque pièce spéciale en créant des parfums différents selon votre goût. Idéal également comme cadeau pour les amis et la famille. Les huiles essentielles ne sont pas incluses. Contenance: 230 ml. Dimensions: Ø 6 cm H 11,5 cm. Décorations: coccinelle, cœur, papillon.



WD710COC

WD710FAR

WD710CUO



Si lavastoviglie
Dishwasher safe
Lave-vaisselle possible

6 cm

11,5 cm





WD709

IT Teiera in vetro borosilicato con filtro in vetro.

La particolarità del manico e del decoro sul tappo rendono la teiera Monterey un articolo di design originale e d'effetto. Capacità: 800ml. Dimensione: Ø 14 H 20 cm. Disponibile in 3 varianti di colore: grigio, verde, blu.

EN Borosilicate glass teapot with glass filter. The special handle and decoration on the stopper make the Monterey teapot an original and impressive design article. Capacity: 800ml. Size: Ø 14 H 20 cm. Available in 3 colour variants: grey, green, blue.

FR Théière en verre borosilicate avec filtre en verre. La poignée spéciale et la décoration du bouchon font de la théière Monterey un article de design original et impressionnant. Contenance: 800ml. Dimensions: Ø 14 H 20 cm. Disponible en 3 couleurs: gris, vert, bleu.



WD709G



WD709V



WD709BL



No lavastoviglie
No dishwasher
Pas de lave-vaisselle



No microonde
Nomicrowave
Pas de micro-ondes



New

WD566PEP



New

WD566QUA



New

WD566SAC



New

WD566MAN



WD566

IT Bicchieri in vetro borosilicato con soggetto in vetro colorato all'interno.

Ogni soggetto è realizzato artigianalmente in vetro soffiato rendendo ogni singolo bicchiere un pezzo unico. Capacità: 250ml. Lavare in lavastoviglie. Per il lavaggio a mano evitare l'utilizzo di spugne o scovolini per non danneggiare il soggetto interno.

EN Glass in borosilicate glass internally decorated with a colored glass element. Capacity: 250ml. Wash in the dishwasher. For hand washing, avoid using sponges or pipe cleaners to avoid damaging the internal subject.

FR Verre borosilicate avec sujet en verre teinté à l'intérieur. Contenance: 250ml. Laver au lave-vaisselle. Pour le lavage à la main, évitez d'utiliser des éponges ou des brosses afin de ne pas endommager le sujet à l'intérieur.

8 cm



8 cm



Si lavastoviglie
Dishwasher safe
Lave-vaisselle possible



Si microonde
Microwave safe
Micro-ondes possible





WD566PEC



WD566TUC



WD566ALL



WD566PEL



WD566KOA



WD566PAN



8 cm



8 cm



Si lavastoviglie
Dishwasher safe
Lave-vaisselle possible



Si microonde
Microwave safe
Micro-ondes possible



WD566RIN

New



WD566GEC

New



WD566

IT Bicchiere in vetro borosilicato con soggetto in vetro colorato all'interno.

Ogni soggetto è realizzato artigianalmente in vetro soffiato rendendo ogni singolo bicchiere un pezzo unico.

Capacità: 250ml. Lavare in lavastoviglie. Per il lavaggio a mano evitare l'utilizzo di spugne o scovolini per non danneggiare il soggetto interno.

EN Glass in borosilicate glass internally decorated with a colored glass element. Capacity: 250ml. Wash in the dishwasher. For hand washing, avoid using sponges or pipe cleaners to avoid damaging the internal subject.

FR Verre borosilicate avec sujet en verre teinté à l'intérieur. Contenance: 250ml. Laver au lave-vaisselle. Pour le lavage à la main, évitez d'utiliser des éponges ou des brosses afin de ne pas endommager le sujet à l'intérieur.

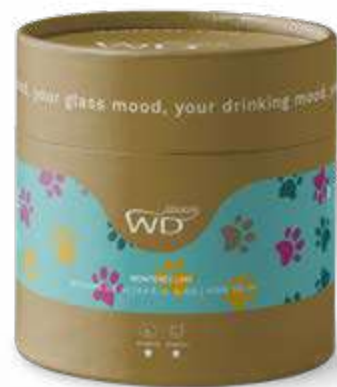

New

WD566CAN

New

WD566GAT

New

WD566ORA

New

WD566ORR

WD566

IT Bicchieri in vetro borosilicato con soggetto in vetro colorato all'interno.

Ogni soggetto è realizzato artigianalmente in vetro soffiato rendendo ogni singolo bicchiere un pezzo unico. Capacità: 250ml. Lavare in lavastoviglie. Per il lavaggio a mano evitare l'utilizzo di spugne o scovolini per non danneggiare il soggetto interno.

EN Glass in borosilicate glass internally decorated with a colored glass element. Capacity: 250ml. Wash in the dishwasher. For hand washing, avoid using sponges or pipe cleaners to avoid damaging the internal subject.

FR Verre borosilicate avec sujet en verre teinté à l'intérieur. Contenance: 250ml. Laver au lave-vaisselle. Pour le lavage à la main, évitez d'utiliser des éponges ou des brosses afin de ne pas endommager le sujet à l'intérieur.

8 cm



Si lavastoviglie
Dishwasher safe
Lave-vaisselle possible



Si microonde
Microwave safe
Micro-ondes possible

WD566

IT Bicchieri in vetro borosilicato con soggetto in vetro colorato all'interno.

Ogni soggetto è realizzato artigianalmente in vetro soffiato rendendo ogni singolo bicchiere un pezzo unico. Capacità: 250ml. Lavare in lavastoviglie. Per il lavaggio a mano evitare l'utilizzo di spugne o scovolini per non danneggiare il soggetto interno.

EN Glass in borosilicate glass internally decorated with a colored glass element. Capacity: 250ml. Wash in the dishwasher. For hand washing, avoid using sponges or pipe cleaners to avoid damaging the internal subject.

FR Verre borosilicate avec sujet en verre teinté à l'intérieur. Contenance: 250ml. Laver au lave-vaisselle. Pour le lavage à la main, évitez d'utiliser des éponges ou des brosses afin de ne pas endommager le sujet à l'intérieur.

8 cm



Si lavastoviglie
Dishwasher safe
Lave-vaisselle possible



Si microonde
Microwave safe
Micro-ondes possible



WD566MED



WD566CAV



WD566COR



WD566DEL

New



WD566GRA



WD566STE



WD566POL



WD566SQU

New

WD566

IT Bicchiere in vetro borosilicato con soggetto in vetro colorato all'interno.

Ogni soggetto è realizzato artigianalmente in vetro soffiato rendendo ogni singolo bicchiere un pezzo unico. Capacità: 250ml. Lavare in lavastoviglie. Per il lavaggio a mano evitare l'utilizzo di spugne o scovolini per non danneggiare il soggetto interno.

EN Glass in borosilicate glass internally decorated with a colored glass element. Capacity: 250ml. Wash in the dishwasher. For hand washing, avoid using sponges or pipe cleaners to avoid damaging the internal subject.

FR Verre borosilicate avec sujet en verre teinté à l'intérieur. Contenance: 250ml. Laver au lave-vaisselle. Pour le lavage à la main, évitez d'utiliser des éponges ou des brosses afin de ne pas endommager le sujet à l'intérieur.



8 cm



8 cm



Si lavastoviglie
Dishwasher safe
Lave-vaisselle possible



Si microonde
Microwave safe
Micro-ondes possible



WD566VOL



WD566CONI



WD566ELE



WD566PAP



WD566FEN



WD566GUF



WD566PAPE



WD566GAL



WD566GAB *New*



WD566FUN



WD566UVA



WD566ZUC



WD566TAR



WD566RAN



WD566

IT Bicchiere in vetro borosilicato con soggetto in vetro colorato all'interno.

Ogni soggetto è realizzato artigianalmente in vetro soffiato rendendo ogni singolo bicchiere un pezzo unico.

Capacità: 250ml. Lavare in lavastoviglie. Per il lavaggio a mano evitare l'utilizzo di spugne o scovolini per non danneggiare il soggetto interno.

EN Glass in borosilicate glass internally decorated with a colored glass element. Capacity: 250ml. Wash in the dishwasher. For hand washing, avoid using sponges or pipe cleaners to avoid damaging the internal subject.

FR Verre borosilicate avec sujet en verre teinté à l'intérieur. Contenance: 250ml. Laver au lave-vaisselle. Pour le lavage à la main, évitez d'utiliser des éponges ou des brosses afin de ne pas endommager le sujet à l'intérieur.

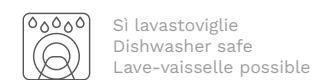
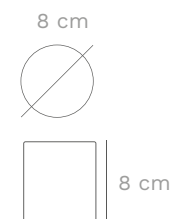



WD566

IT Bicchiere in vetro borosilicato con soggetto in vetro colorato all'interno.

Ogni soggetto è realizzato artigianalmente in vetro soffiato rendendo ogni singolo bicchiere un pezzo unico.

Capacità: 250ml. Lavare in lavastoviglie. Per il lavaggio a mano evitare l'utilizzo di spugne o scovolini per non danneggiare il soggetto interno.

EN Glass in borosilicate glass internally decorated with a colored glass element. Capacity: 250ml. Wash in the dishwasher. For hand washing, avoid using sponges or pipe cleaners to avoid damaging the internal subject.

FR Verre borosilicate avec sujet en verre teinté à l'intérieur. Contenance: 250ml. Laver au lave-vaisselle. Pour le lavage à la main, évitez d'utiliser des éponges ou des brosses afin de ne pas endommager le sujet à l'intérieur.



WD566APE



WD566COC



WD566FAR



WD566GIR



WD566MAR



WD566TUL

8 cm



8 cm



Si lavastoviglie
Dishwasher safe
Lave-vaisselle possible



Si microonde
Microwave safe
Micro-ondes possible





WD566ARA



WD566FRA



WD566MEL



WD566LIM



WD566BOR



WD566CUO



WD566SCA



WD566LUC



WD566

IT Bicchiere in vetro borosilicato con soggetto in vetro colorato all'interno.

Ogni soggetto è realizzato artigianalmente in vetro soffiato rendendo ogni singolo bicchiere un pezzo unico. Capacità: 250ml. Lavare in lavastoviglie. Per il lavaggio a mano evitare l'utilizzo di spugne o scovolini per non danneggiare il soggetto interno.

EN Glass in borosilicate glass internally decorated with a colored glass element. Capacity: 250ml. Wash in the dishwasher. For hand washing, avoid using sponges or pipe cleaners to avoid damaging the internal subject.

FR Verre borosilicate avec sujet en verre teinté à l'intérieur. Contenance: 250ml. Laver au lave-vaisselle. Pour le lavage à la main, évitez d'utiliser des éponges ou des brosses afin de ne pas endommager le sujet à l'intérieur.

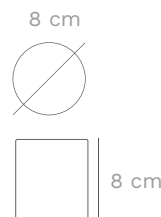

WD566

IT Bicchiere in vetro borosilicato con soggetto in vetro colorato all'interno.

Ogni soggetto è realizzato artigianalmente in vetro soffiato rendendo ogni singolo bicchiere un pezzo unico. Capacità: 250ml. Lavare in lavastoviglie. Per il lavaggio a mano evitare l'utilizzo di spugne o scovolini per non danneggiare il soggetto interno.

EN Glass in borosilicate glass internally decorated with a colored glass element. Capacity: 250ml. Wash in the dishwasher. For hand washing, avoid using sponges or pipe cleaners to avoid damaging the internal subject.

FR Verre borosilicate avec sujet en verre teinté à l'intérieur. Contenance: 250ml. Laver au lave-vaisselle. Pour le lavage à la main, évitez d'utiliser des éponges ou des brosses afin de ne pas endommager le sujet à l'intérieur.

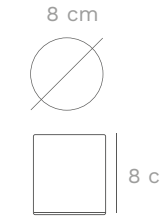



WD633CUP



WD633TOR



WD633

IT Tazza in vetro borosilicato con soggetto in vetro colorato all'interno.

Ogni soggetto è realizzato artigianalmente in vetro soffiato rendendo ogni singola tazza un pezzo unico. Capacità: 420ml. Lavare in lavastoviglie. Per il lavaggio a mano evitare l'utilizzo di spugne o scovolini per non danneggiare il soggetto interno.

EN Borosilicate glass mug with colored glass subject inside. Each subject is handcrafted in blown glass making each cup a unique piece. Capacity: 420ml. Wash in the dishwasher. For hand washing, avoid using sponges or pipe cleaners to avoid damaging the internal subject.

FR Tasse en verre borosilicate avec sujet en verre coloré à l'intérieur. Chaque sujet est fabriqué à la main en verre soufflé, ce qui fait de chaque tasse une pièce unique. Contenance: 420ml. Lavable au lave-vaisselle. Pour le lavage à la main, évitez d'utiliser des éponges ou des cure-pipes pour ne pas endommager le sujet à l'intérieur.

 Sì lavastoviglie
Dishwasher safe
Lave-vaisselle possible

 Sì microonde
Microwave safe
Micro-ondes possible

8 cm



11 cm





WD633SCO



WD633CER



WD633CAN



WD633GAT



WD633

IT Tazza in vetro borosilicato con soggetto in vetro colorato all'interno.

Ogni soggetto è realizzato artigianalmente in vetro soffiato rendendo ogni singola tazza un pezzo unico. Capacità: 420ml. Lavare in lavastoviglie. Per il lavaggio a mano evitare l'utilizzo di spugne o scovolini per non danneggiare il soggetto interno.

EN Borosilicate glass mug with colored glass subject inside. Each subject is handcrafted in blown glass making each cup a unique piece. Capacity: 420ml. Wash in the dishwasher. For hand washing, avoid using sponges or pipe cleaners to avoid damaging the internal subject.

FR Tasse en verre borosilicate avec sujet en verre coloré à l'intérieur. Chaque sujet est fabriqué à la main en verre soufflé, ce qui fait de chaque tasse une pièce unique. Contenance: 420ml. Lavable au lave-vaisselle. Pour le lavage à la main, évitez d'utiliser des éponges ou des cure-pipes pour ne pas endommager le sujet à l'intérieur.

 Sì lavastoviglie
Dishwasher safe
Lave-vaisselle possible

 Sì microonde
Microwave safe
Micro-ondes possible

8 cm





WD585ANG



WD585ANC



WD585FOC

New

WD585

IT Bottiglia in vetro borosilicato con tappo con chiusura ermetica e decoro in vetro colorato all'interno.

Soggetto realizzato artigianalmente in vetro soffiato, ogni singola bottiglia è un pezzo unico. Capacità: 1,2L.

EN Bottle in borosilicate glass with watertight lid and internally decorated with an element in colored glass. Element handcrafted in blown glass, each bottle is a unique piece. Capacity: 1,2L.

FR Bouteille en verre borosilicate avec bouchon et décoration en verre coloré à l'intérieur. Fabriquée à la main en verre soufflé, chaque bouteille est une pièce unique. Capacité: 1,2L.



Si lavastoviglie
Dishwasher safe
Lave-vaisselle possible



Si microonde
Microwave safe
Micro-ondes possible

8,5 cm



30 cm

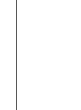



WD565NIN



WD565CUO

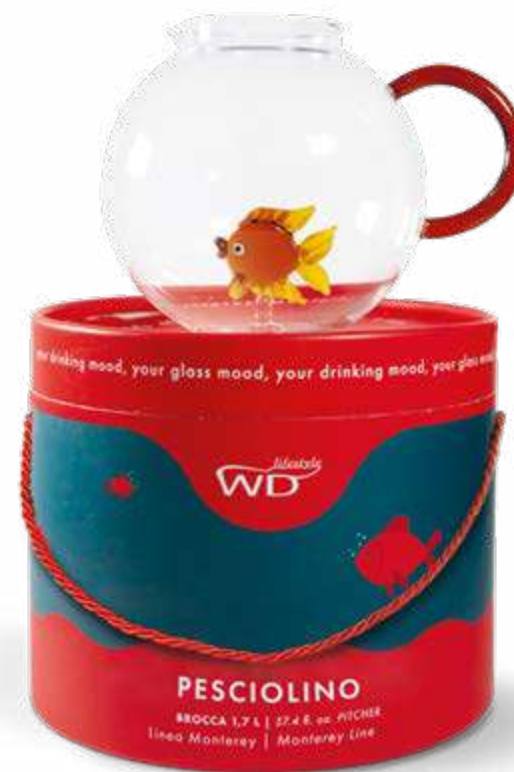

WD565PES



WD565CIL

-  Si lavastoviglie
Dishwasher safe
Lave-vaisselle possible
-  Si microonde
Microwave safe
Micro-ondes possible

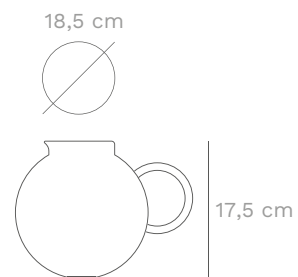

WD565

IT Brocca in vetro borosilicato con soggetto in vetro colorato all'interno.

Ogni soggetto è realizzato artigianalmente in vetro soffiato rendendo ogni singola brocca un pezzo unico. Disponibile con quattro figure differenti. Scegli il tuo drinking mood e sperimenta i vari abbinamenti ottenendo una tavola gioiosa e raffinata. Capacità: 1,7L.

EN Pitcher in borosilicate glass internally decorated with a element in colored glass. Each inside element is handcrafted in blown glass, making every single pitcher a unique piece. Available with four different elements. Choose your drinking mood and experiment with the various combinations to create a joyful and refined table. Capacity: 1,7L.

FR Pichet en verre borosilicate avec figurine en verre à l'intérieur. Fabriquée à la main en verre soufflé, chaque bouteille est une pièce unique. Disponible en quatre figurines différentes. Contenance: 1,7L.



WD564BAL



WD564ARA



WD564SOT



WD564QUA

- 

 Si lavastoviglie
 Dishwasher safe
 Lave-vaisselle possible
- 

 Si microonde
 Microwave safe
 Micro-ondes possible

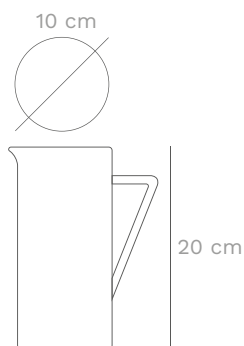

WD564

IT Caraffa in vetro borosilicato con decoro in vetro all'interno.

Ogni soggetto è realizzato artigianalmente in vetro soffiato rendendo ogni singola caraffa un pezzo unico. Capacità: 1,2L. Per il lavaggio a mano evitare l'utilizzo di spugne o scovolini per non danneggiare il soggetto interno.

EN Carafe in borosilicate glass internally decorated with a element in colored glass. Each figure is handcrafted in blown glass making every single pitcher a unique piece. Capacity: 1,2L. For hand washing, avoid using sponges or pipe cleaners to avoid damaging the internal subject.

FR Carafe en verre borosilicate avec figurine en verre à l'intérieur. Chaque sujet est fabriqué à la main en verre soufflé, ce qui fait de chaque carafe une pièce unique. Contenance: 1,2L. Laver au lave-vaisselle. Pour le lavage à la main, évitez d'utiliser des éponges et des brochettes afin de ne pas endommager le sujet à l'intérieur. Pour le lavage à la main, évitez d'utiliser des éponges ou des brosses afin de ne pas endommager le sujet à l'intérieur.



WD645PEP

IT Oliera in vetro borosilicato con decoro peperoncino in vetro colorato all'interno

Beccuccio anti-goccia per dosare correttamente l'olio nelle tue pietanze. Grazie alle proprietà del vetro borosilicato è molto resistente ed allo stesso tempo particolarmente trasparente e leggera. Capacità 250ml.

EN Oil jug made of borosilicate glass with colored glass chili pepper decoration inside. Anti-drip spout to properly dose the oil into your dishes. Thanks to the properties of borosilicate glass it is very resistant and at the same time particularly transparent and light. Capacity: 250ml.

FR Huilier en verre borosilicate avec décoration piment en verre coloré à l'intérieur. Bec verseur anti-goutte pour doser correctement l'huile dans vos plats. Grâce aux propriétés du verre borosilicate, il est très résistant et en même temps particulièrement transparent et léger. Contenance 250ml.

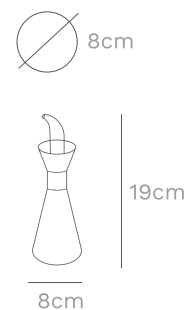

WD644OLI

IT Oliera in vetro borosilicato con decoro olive in vetro colorato all'interno.

Beccuccio anti-goccia per dosare correttamente l'olio nelle tue pietanze. Grazie alle proprietà del vetro borosilicato è molto resistente ed allo stesso tempo particolarmente trasparente e leggera. Capacità 500ml.

EN Oil jug made of borosilicate glass with colored glass olive decoration inside. Anti-drip spout to properly dose the oil into your dishes. Thanks to the properties of borosilicate glass it is very resistant and at the same time particularly transparent and light. Capacity: 500ml.

FR Huilier en verre borosilicate avec décoration d'olives en verre coloré à l'intérieur. Bec verseur anti-goutte pour doser correctement l'huile dans vos plats. Grâce aux propriétés du verre borosilicate, il est très résistant et en même temps particulièrement transparent et léger. Contenance 500ml.

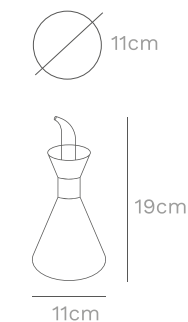



WD636CAC

WD636CAM

WD636GIR

WD636

IT Clessidra in vetro borosilicato con sabbia colorata e soggetto in vetro colorato all'interno

Durata: 30 min. Tenere in un luogo asciutto per evitare che la sabbia si addensi.

EN Hourglass in borosilicate glass with colored sand and colored glass subject inside.
Duration: 30 min. Keep in a dry place to prevent sand from thickening.

FR Sablier en verre borosilicaté avec sable coloré et sujet en verre coloré à l'intérieur.
Durée: 30 min. Conserver dans un endroit sec pour éviter que le sable ne s'épaississe.

8 cm



20 cm



WD624GI



WD624BL



WD624V



Si lavastoviglie
Dishwasher safe
Lave-vaisselle possible



Si microonde
Microwave safe
Micro-ondes possible



6,5 cm

WD624

IT Set 2 bicchierini in vetro borosilicato doppia parete.

La parete interna è realizzata in vetro colorato mentre quella esterna in vetro trasparente. Ideali per servire caffè, grappe e liquori. Il vetro borosilicato sopporta le alte e basse temperature e la doppia parete le mantiene più a lungo. Capacità: 100ml. Disponibile in 3 varianti di colore: giallo, blu, verde.

EN Set of 2 double-walled borosilicate glass cups. The inner wall is made of coloured glass while the outer one is made of transparent glass. Ideal for serving coffee, grappa and liqueurs. Borosilicate glass withstands high and low temperatures, and the double wall keeps them longer. Capacity: 100ml. Available in 3 color variants: yellow, blue, green.

FR Ensemble de 2 gobelets double paroi en verre borosilicate. La paroi intérieure est en verre coloré. Le gobelet double paroi permet de conserver la chaleur plus longtemps. Le verre borosilicate résiste aux températures élevées. Idéal pour les boissons chaudes ou fraîches. Contenance: 100ml. Disponible en 3 variantes de couleurs: jaune, bleu, vert.





WD625GI



WD625BL



WD625V

WD625

IT Set 2 bicchieri in vetro borosilicato doppia parete.

La parete interna è realizzata in vetro colorato mentre quella esterna in vetro trasparente. Ideali per servire bevande fresche o calde, grazie alle caratteristiche del vetro borosilicato che sopporta le alte e basse temperature. La doppia parete mantiene inoltre più a lungo la temperatura. Capacità: 220ml. Disponibile in 3 varianti di colore: giallo, blu, verde.

EN Set of 2 double wall borosilicate glass glasses. The inner wall is made of coloured glass while the outer one is made of transparent glass. Ideal for serving cool or hot drinks, thanks to the characteristics of borosilicate glass that withstands high and low temperatures. The double wall also maintains the temperature longer. Capacity: 220ml. Available in 3 color variants: yellow, blue, green.

FR Ensemble de 2 verres double paroi en verre borosilicate. La paroi intérieure est en verre coloré. Le gobelet double paroi permet de conserver la chaleur ou le frais plus longtemps. Le verre borosilicate résiste aux températures élevées. Idéal pour les boissons chaudes ou fraîches. Contenance: 220ml. Disponible en 3 variantes de couleurs: jaune, bleu, vert.



Si lavastoviglie
Dishwasher safe
Lave-vaisselle possible



Si microonde
Microwave safe
Micro-ondes possible



7,5 cm



11 cm



WD626GI



WD626BL



WD626V

WD626

IT Caraffa in vetro borosilicato doppia parete.

La parete interna è realizzata in vetro colorato mentre quella esterna in vetro trasparente. Ideale per servire bevande fresche o calde, grazie alle caratteristiche del vetro borosilicato che sopporta le alte e basse temperature. La doppia parete mantiene inoltre più a lungo la temperatura. Capacità: 900ml. Disponibile in 3 varianti di colore: giallo, blu, verde.

EN Double wall borosilicate glass carafe. The inner wall is made of coloured glass while the outer one is made of transparent glass. Ideal for serving cool or hot drinks, thanks to the characteristics of borosilicate glass that withstands high and low temperatures. The double wall also maintains the temperature longer. Capacity: 900ml. Available in 3 color variants: yellow, blue, green.

FR Pichet double paroi en verre borosilicate. La paroi intérieure est en verre coloré. Le pichet double paroi permet de conserver la chaleur ou le frais plus longtemps. Le verre borosilicate résiste aux températures élevées. Idéal pour les boissons chaudes ou fraîches. Contenance: 900ml. Disponible en 3 variantes de couleurs: jaune, bleu, vert.

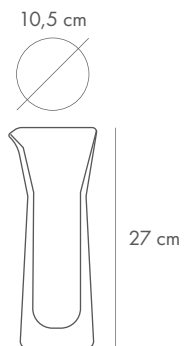

WD627GI



WD627BL



WD627V

WD627

IT Set 2 ciotole in vetro borosilicato doppia parete.

La parete interna è realizzata in vetro colorato mentre quella esterna in vetro trasparente. Ideali per tiramisù, finger food, gelati, mousse o macedonia. Il vetro borosilicato sopporta le alte e basse temperature e la doppia parete le mantiene più a lungo. Capacità: 180ml. Disponibile in 3 varianti di colore: giallo, blu, verde.

EN Set of 2 bowls in double wall borosilicate glass. The inner wall is made of coloured glass while the outer one is made of transparent glass. Ideal for tiramisù, finger food, ice cream, mousse or fruit salad. Borosilicate glass withstands high and low temperatures, and the double wall keeps them longer. Capacity: 180ml. Available in 3 color variants: yellow, blue, green.

FR Set de 2 coupelles double paroi en verre borosilicate. La paroi intérieure est en verre coloré. La coupelle double paroi permet de conserver la chaleur ou le frais plus longtemps. Le verre borosilicate résiste aux températures élevées. Idéal pour les boissons chaudes ou fraîches. Contenance: 180ml. Disponible en 3 variantes de couleurs: jaune, bleu, vert.

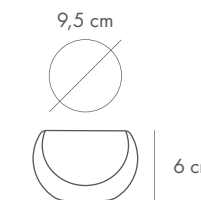

6 cm



Si lavastoviglie
Dishwasher safe
Lave-vaisselle possible



Si microonde
Microwave safe
Micro-ondes possible

WD632

IT Set di 2 flûte a doppia parete in vetro borosilicato.

La doppia parete mantiene il tuo champagne fresco più a lungo rispetto al vetro a parete singola. Il design tubolare facilita la presa mentre lo stelo cavo consente bolle più lisce e un'emanazione più uniforme degli aromi. Grazie al design originale, saranno perfetti per le tue occasioni speciali. Capacità: 150ml.

EN Set of 2 double wall flutes in borosilicate glass. The double wall keeps your champagne cool for longer than single wall glass. The tubular design makes it easier to hold while the hollow stem allows for smoother bubbles and a more uniform emanation of aromatic compounds. Thanks to the original design, they will be perfect for your special occasions. Capacity: 150ml.

FR Ensemble de 2 flûtes à double paroi en verre borosilicate. La double paroi permet de conserver la fraîcheur de votre champagne plus longtemps que les verres à simple paroi. La forme tubulaire facilite la prise en main, tandis que la tige creuse permet des bulles plus douces et une libération plus uniforme des arômes. Grâce à leur design original, ils seront parfaits pour vos occasions spéciales. Contenance: 150ml.

5 cm



23 cm



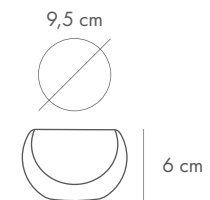

WD318

IT Set 6 ciotole in vetro borosilicato doppia parete 170ml.
EN Set of 6 bowls in borosilicate glass, double wall 170ml.
FR Set de 6 bols en verre borosilicate à double paroi de 170ml.

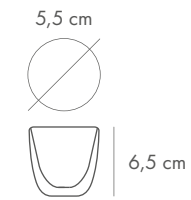

WD174

IT Set 6 bicchierini, doppia parete 90ml
EN Set of 6 small glasses, double wall 90ml.
FR Set de 6 petits verres à double paroi de 90ml.



Si lavastoviglie
Dishwasher safe
Lave-vaisselle possible



Si microonde
Microwave safe
Micro-ondes possible

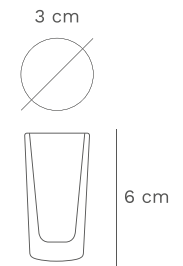

WD319

IT Set 6 bicchierini liquore in vetro borosilicato doppia parete 100ml.
EN Set of 6 glasses in borosilicate glass, double wall 100ml.
FR Set de 6 verres à liqueur en verre borosilicate à double paroi de 100ml.



WD173

IT Brocca doppia parete 900ml.
EN Double glass Pitcher 900ml.
FR Carafe à double paroi de 900ml.



No lavastoviglie
No dishwasher
Pas de lave-vaisselle



Si microonde
Microwave safe
Micro-ondes possible



8 cm



8 cm

WD615

IT Set 6 bicchieri in vetro borosilicato con scritta decorativa e fondo colorato. Capacità: 250ml.

EN Set composed by 6 glasses in borosilicate glass with decorating quote and colored bottom. Capacity: 250ml.

WDF615 *Sans écriture*

FR Ensemble de 6 verres en verre borosilicate et fond coloré. Contenance: 250ml.





WD606

IT Caraffa in vetro borosilicato
con manico blu e scritta decorativa. Capacità: 1,3L.

EN Borosilicate glass jug with blue handle and decorating quote.
Capacity: 1,3L.

WDF606 *Sans écriture*

FR Pichet en verre borosilicate avec poignée teintée en bleue dans la masse du verre. Contenance: 1,3L.



Si lavastoviglie
Dishwasher safe
Lave-vaisselle possible



Si microonde
Microwave safe
Micro-ondes possible

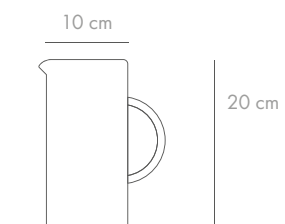



Si lavastoviglie
Dishwasher safe
Lave-vaisselle possible



Si microonde
Microwave safe
Micro-ondes possible

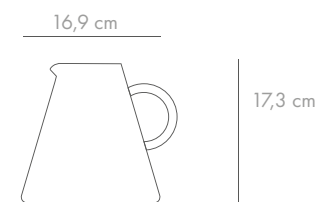

WD605

IT Brocca decanter in vetro borosilicato con manico marrone e scritta decorativa. La sua forma moderna rende questo decanter unico e originale. Capacità: 1,6L.

EN Borosilicate glass pitcher decanter with brown handle and decorating quote. Its modern shape gives this decanter an original and unique look. Capacity: 1,6L.

WDF605 *Sans écriture*

FR Carafe en verre borosilicate avec poignée colorée. Sa forme moderne rend cette carafe unique et originale. Capacité: 1,6L.





WD603



WD604



Si lavastoviglie
Dishwasher safe
Lave-vaisselle possible



Si microonde
Microwave safe
Micro-ondes possible

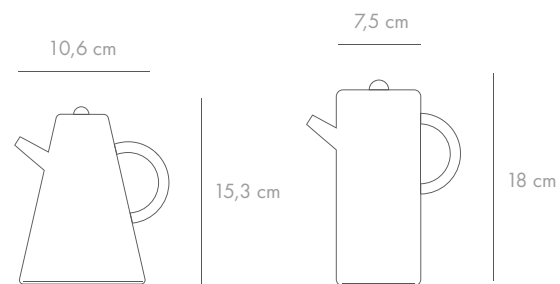

WD603

IT Oliera in vetro borosilicato con manico giallo e scritta decorativa. La sua forma moderna rende questa oliera unica e originale. Capacità: 500ml.

EN Borosilicate glass oil bottle with yellow handle and decorating quote. The modern shape gives this oil bottle an original and unique look. Capacity: 500ml.

WDF603 *Sans écriture*

FR Pichet à huile en verre borosilicate avec poignée jaune. Sa forme moderne rend ce pichet à huile unique et original. Contenance: 500ml.

WD604

IT Oliera in vetro borosilicato con manico marrone e scritta decorativa. La sua forma moderna rende questa oliera unica e originale. Capacità: 500ml.

EN Borosilicate glass oil bottle with brown handle and decorating quote. The modern shape gives this oil bottle an original and unique look. Capacity: 500ml.

WDF604 *Sans écriture*

FR Pichet à huile en verre borosilicate avec poignée marron. Sa forme moderne rend ce pichet à huile unique et original. Contenance: 500ml.



WD598

IT Set 6 tazzine da caffè in vetro borosilicato con manico colorato e scritta decorativa. La forma moderna di queste tazzine le rende uniche e originali. Capacità: 100ml.

EN Set composed by 6 coffee cups in borosilicate glass with colored handle and decorating quote. The modern shape of these coffee cups make them unique and original. Capacity: 100ml.

WDF598 *Sans écriture*

FR Set de 6 tasses à café en verre borosilicate avec poignée colorée. La forme moderne de ces tasses les rend uniques et originales. Contenance: 100ml.



Si lavastoviglie
Dishwasher safe
Lave-vaisselle possible



Si microonde
Microwave safe
Micro-ondes possible

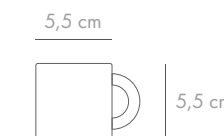



WD597

IT Set 4 tazze da tè in vetro borosilicato con manico colorato e scritta decorativa. La forma moderna di queste tazze le rende uniche e originali. Capacità: 250ml.

EN Set composed by 4 tea cups in borosilicate glass with colored handle and decorating quote. The modern shape of these tea cups make them unique and original. Capacity: 250ml.



WDF597 *Sans écriture*

FR Set de 4 mugs en borsilicate avec poignée colorée. La forme moderne de ces tasses les rend uniques et originales. Contenance: 250ml.



Si lavastoviglie
Dishwasher safe
Lave-vaisselle possible



Si microonde
Microwave safe
Micro-ondes possible

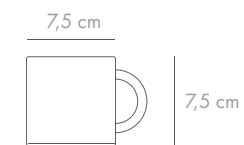



WD596B



WD596V

WD596

IT Teiera in vetro borosilicato con manico colorato e scritta decorativa. La sua forma moderna e il filtro sul beccuccio rendono questa teiera unica e originale. Disponibile in due colori. Capacità: 900ml.

EN Borosilicate glass teapot with colored handle and decorating quote. Its modern shape and the filter on the spout give this teapot an original and unique look. Available in two different colors. Capacity: 900ml.

WDF596 *Sans écriture*

FR Théière en verre borosilicate avec filtre ressort sur le bec verseur. Elle est équipée d'un filtre ressort. Les poignées en verre teinté dans la masse sont proposées en deux couleurs: verte et banche. Contenance: 900ml.

FILTRO | FILTER | FILTRE



No microonde
Nomicrowave
Pas de micro-ondes

TEIERA | TEAPOT | THÉIÈRE



Si lavastoviglie
Dishwasher safe
Lave-vaisselle possible



Si microonde
Microwave safe
Micro-ondes possible

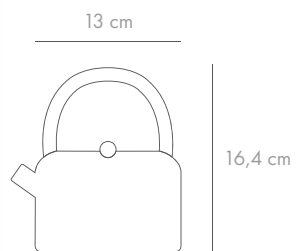



WD599GI



WD599V

WD599

IT Tisaniera in vetro borosilicato con manico colorato, filtro in acciaio inossidabile con tappo in vetro e scritta decorativa. La forma moderna di questa tisaniera la rende unica e originale. Disponibile in due colori. Capacità: 420ml.

EN Mug in borosilicate glass with colored handle, stainless steel filter with glass lid and decorative quote. The modern shape of this mug makes it unique and original. Available in two different colors. Capacity: 420ml.

WDF599 *Sans écriture*

FR Coffret Tisanière borosilicate avec filtre en INOX. Couvercle en verre. Deux couleurs possibles pour les poignées teintées dans la masse. Contenance: 420ml.

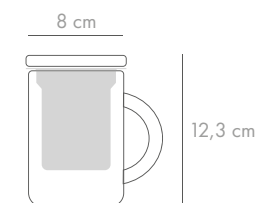



WD600



WD601B



WD602

IT Barattoli in vetro borosilicato con tappo ermetico, manico colorato e scritta decorativa.

EN Jars in borosilicate glass with airtight lid, colored handle and decorating quote.

Sans écriture

FR Canister en verre borosilicate, avec couvercle hermétique par un joint silicone, poignée teintée dans la masse.

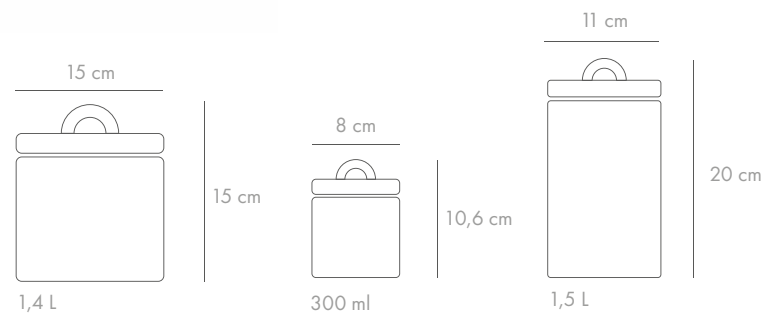

 Si lavastoviglie
Dishwasher safe
Lave-vaisselle possible

 Si microonde
Microwave safe
Micro-ondes possible



LINEA AUSTIN



WD725 *New*

IT Porta zampironi in metallo.

Dotato di griglia con pattern decorativo, utilizzabile da tavolo con manico pieghevole oppure con stelo (modulabile in altezza) da inserire nel terreno per posizionarlo ovunque tu voglia. Il magnete ti permette il suo miglior utilizzo con o senza stelo. Rendi ogni ambiente originale, colorato ma soprattutto al sicuro da tutti gli insetti. Zampirone escluso. Disponibile in 6 varianti di colore: Antracite, Arancio, Crema, Blu, Verde, Senape.

EN Metal lantern holder. Equipped with a grid with a decorative pattern, can be used on the table with a foldable handle or with a stem (adjustable in height) to be inserted into the ground for placement wherever you want. The magnet allows you to use it with or without the stem. Make every environment original, colorful, but above all, safe from all insects. Lantern not included. Available in 6 color variations: Anthracite, Orange, Cream, Blue, Green, Mustard-colored.

FR Support de lanterne en métal. Équipé d'une grille avec un motif décoratif, peut être utilisé sur la table avec une poignée pliable ou avec une tige (réglable en hauteur) à insérer dans le sol pour le placer où vous le souhaitez. L'aimant vous permet de l'utiliser avec ou sans la tige. Rendez chaque environnement original, coloré, mais surtout à l'abri de tous les insectes. Lanterne non incluse. Disponible en 6 variations de couleur: Anthracite, Orange, Crème, Bleu, Vert, Moutarde.



WD725AN



WD725AR



WD725BL



WD725CR



WD725SEN



WD725V

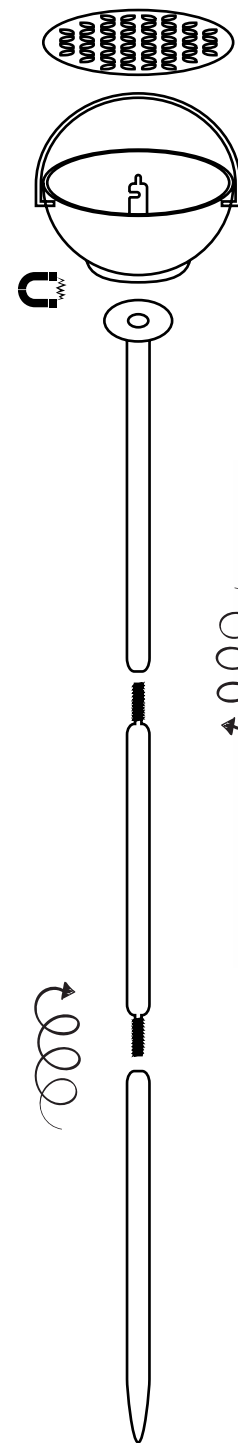

Stelo modulare

Adjustable stem

Réglable tige

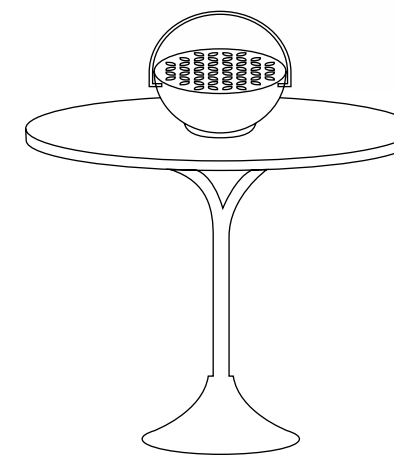
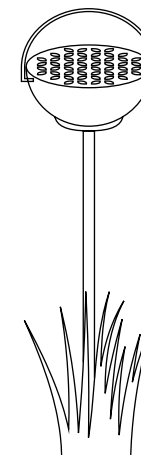

WD726 *New*

IT Set pochette termica e asciugamano in microfibra.

Due accessori comodi per vivere con stile le tue giornate outdoor. Pochette adatta a riporre il tuo asciugamano, perfetta anche per tenere il tuo telefono, bibite e snack riparati da sole. Disponibile in 4 varianti: Blu, Verde, Arancio, Giallo.

EN Set of cooler pouch and microfiber towel. Two convenient accessories to live your outdoor days in style. The pouch is suitable for storing your towel, perfect also for keeping your phone, drinks, and snacks sheltered from the sun. Available in 4 variants: Blue, Green, Orange, Yellow.

FR Set de pochette isotherme avec serviette en microfibre. Deux accessoires pratiques pour vivre vos journées en plein air avec style. La pochette est idéale pour ranger votre serviette, parfaite également pour protéger votre téléphone, vos boissons et vos collations du soleil. Disponible en 4 variantes: Bleu, Vert, Orange, Jaune.



WD726AR



WD726BL



WD726GI



WD726V

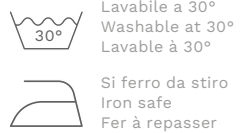

Lavabile a 30°
Washable at 30°
Lavable à 30°

Si ferro da stiro
Iron safe
Fer à repasser

90 cm

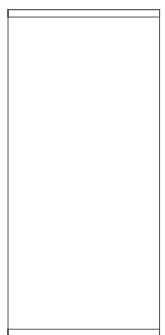

200 cm

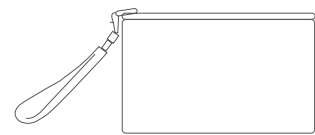

21 cm

30 cm



WD727 *New*

IT Borsa termica modello tote 18L.

Comoda e pratica, perfetta per mantenere al fresco cibo e bevande durante le giornate fuori porta o in ufficio. Disponibile in 2 varianti: blu e bianca, multicolor.

EN Tote cooler bag, 18L. Comfortable and practical, perfect for keeping food and drinks cool during outdoor days or at the office. Available in 2 variations: blue and white, multicolor.

FR Sac isotherme de type tote, 18L. Confortable et pratique, parfait pour maintenir au frais les aliments et les boissons lors des sorties en plein air ou au bureau. Disponible en 2 variantes: bleu et blanc, multicolore.



WD727BL



WD727GI

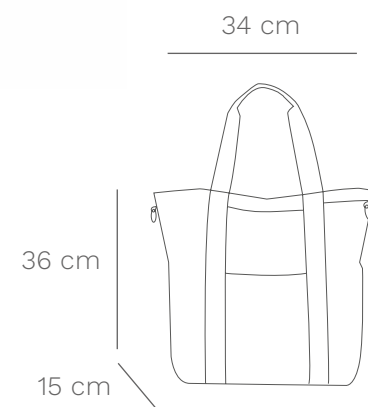

WD728 *New*

IT Zaino termico 16L.

Comodo e pratico, perfetto per mantenere al fresco cibo e bevande durante le giornate fuori porta. Disponibile in 2 varianti: blu e bianca, multicolor.

EN Cooler backpack 16L. Comfortable and practical, perfect for keeping food and drinks cool during outdoor days. Available in 2 variations: blue and white, multicolor.

FR Sac à dos isotherme 16L. Confortable et pratique, parfait pour maintenir au frais les aliments et les boissons lors des sorties en plein air. Disponible en 2 variantes: bleu et blanc, multicolore.



WD728BL



WD728GI

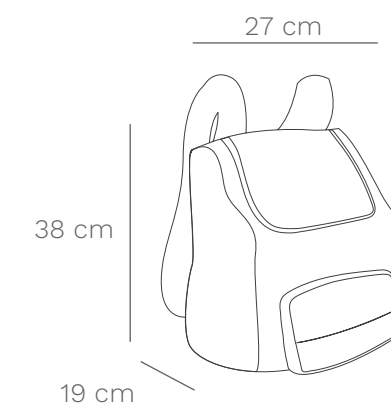

WD729 *New*

IT Borsa termica 25L con tasca portabottiglie.

Capiente e pratica, perfetta per mantenere al fresco cibo e bevande durante le giornate fuori porta. Disponibile in 2 varianti: blu e bianca, multicolor.

EN Cooler bag 25L with bottle holder pocket. Spacious and practical, perfect for keeping food and drinks cool during outdoor days. Available in 2 variations: blue and white, multicolor.

FR Sac isotherme 25L avec poche porte-bouteille. Spacieux et pratique, parfait pour maintenir au frais les aliments et les boissons lors des sorties en plein air. Disponible en 2 variantes: bleu et blanc, multicolore.



WD729BL

WD729GI

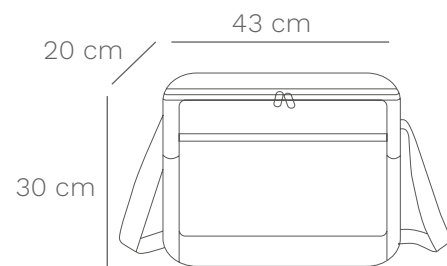

WD730 *New*

IT Borsa termica in vimini bianco.

Capiente e originale, perfetta per mantenere al fresco cibo e bevande durante le giornate fuori porta.

EN Wicker cooler bag. Spacious and unique, perfect for keeping food and drinks cool during outdoor outings.

FR Sac isotherme en osier. Spacieux et original, parfait pour maintenir au frais les aliments et les boissons lors des sorties en plein air.



WD730

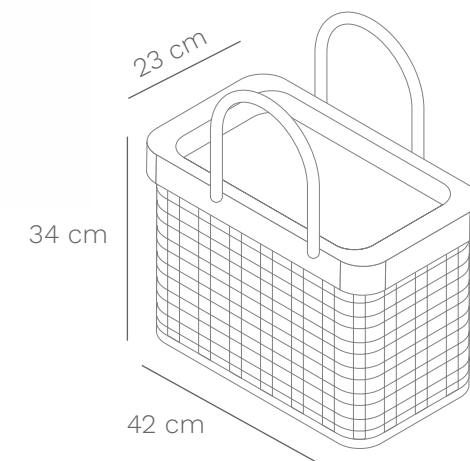

Lavare con un panno umido
Wash with a damp cloth
Laver avec un chiffon humide

WD731 *New*

IT Cestino da picnic in vimini bianco per 2 persone.

Decorato con tessuto a righe multicolor, comodo e pratico grazie alla sua tracolla regolabile. Contiene 2 piatti in ceramica; 2 forchette, 2 coltelli, 2 cucchiaini, 1 cavatappi in acciaio inox; 2 calici in vetro; 1 borsa termica.

EN White wicker picnic basket for 2 people. Decorated with multicolored striped fabric, comfortable and practical thanks to its adjustable shoulder strap. Contains 2 ceramic plates; 2 forks, 2 knives, 2 spoons, 1 stainless steel corkscrew; 2 glass tumblers; 1 cooler bag.

FR Panier de pique-nique en osier blanc pour 2 personnes. Décoré avec un tissu à rayures multicolores, confortable et pratique grâce à sa bandoulière réglable. Contient 2 assiettes en céramique; 2 fourchettes, 2 couteaux, 2 cuillères, 1 tire-bouchon en acier inoxydable; 2 verres; 1 sac thermique.



X 2



X 2



X 1



X 2

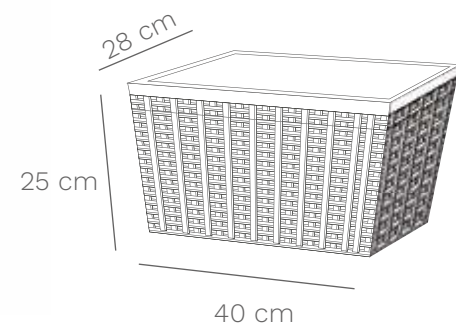

WD732 *New*

IT Cestino da picnic in vimini color miele per 2 persone.

Decorato con tessuto a righe multicolor, comodo e pratico. Contiene 2 piatti in ceramica; 2 forchette, 2 coltelli, 2 cucchiaini, 1 cavatappi in acciaio inox; 2 calici in vetro.

EN Honey-colored wicker picnic basket for 2 people. Decorated with multicolored striped fabric, comfortable and practical. Contains 2 ceramic plates; 2 forks, 2 knives, 2 spoons, 1 stainless steel corkscrew; 2 glass goblets.

FR Panier de pique-nique en osier couleur miel pour 2 personnes. Décoré avec un tissu à rayures multicolores, confortable et pratique. Contient 2 assiettes en céramique; 2 fourchettes, 2 couteaux, 2 cuillères, 1 tire-bouchon en acier inoxydable; 2 verres.



X 2



X 2



X 1



X 2

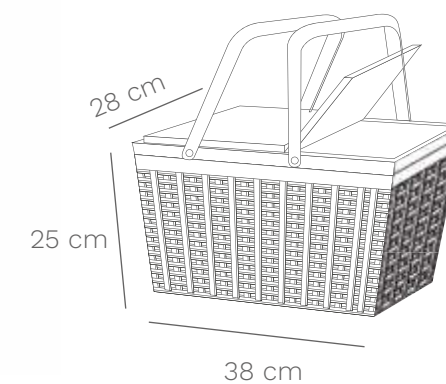

WD733 *New*

IT Cestino da picnic in vimini bianco per 4 persone.

Decorato con tessuto a righe bianche, comodo e pratico grazie alla sua tracolla regolabile. Contiene 4 piatti in ceramica; 4 forchette, 4 coltelli, 4 cucchiaini, 1 cavatappi in acciaio inox; 4 calici in vetro; 1 borsa termica; 1 tovaglia dal fondo impermeabile.

EN White wicker picnic basket for 4 people. Decorated with white striped fabric, comfortable and practical with its adjustable shoulder strap. Contains 4 ceramic plates; 4 forks, 4 knives, 4 spoons, 1 stainless steel corkscrew; 4 glass goblets; 1 thermal bag; 1 tablecloth with a waterproof bottom.

FR Panier de pique-nique en osier blanc pour 4 personnes. Décoré avec un tissu à rayures blanches, confortable et pratique avec sa bandoulière réglable. Contient 4 assiettes en céramique; 4 fourchettes, 4 couteaux, 4 cuillères, 1 tire-bouchon en acier inoxydable; 4 verres; 1 sac thermique; 1 nappe avec un fond imperméable.



X 4



X 4



X 1



X 4

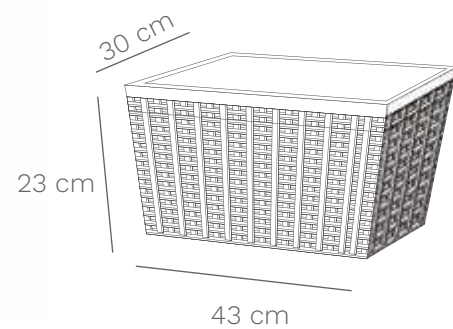

WD734 *New*

IT Cestino da picnic in vimini color miele per 4 persone.

Decorato con tessuto a righe multicolor, comodo e pratico. Contiene 4 piatti in ceramica; 4 forchette, 4 coltelli, 4 cucchiaini, 1 cavatappi in acciaio inox; 4 calici in vetro.

EN Honey-colored wicker picnic basket for 4 people. Decorated with multicolored striped fabric, comfortable and practical. Contains 4 ceramic plates; 4 forks, 4 knives, 4 spoons, 1 stainless steel corkscrew; 4 glass goblets.

FR Panier de pique-nique en osier de couleur miel pour 4 personnes. Décoré avec un tissu à rayures multicolores, confortable et pratique. Contient 4 assiettes en céramique; 4 fourchettes, 4 couteaux, 4 cuillères, 1 tire-bouchon en acier inoxydable; 4 verres en verre.



X 4



X 4



X 1



X 4

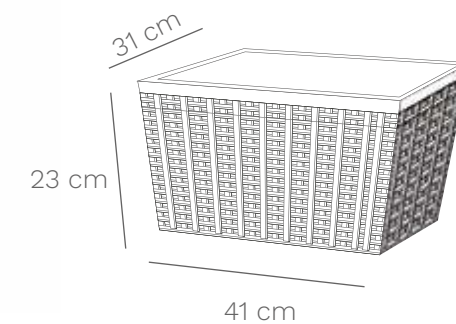

WD735 *New*

IT Cooler bag rigida 12L.

Adatta per conservare al fresco cibo e bevande. Dotata di manico rigido e tracolla regolabile intercambiabili tra loro in base alle tue esigenze. Il suo coperchio può essere anche utilizzato come vassoio portabibite. Disponibile in 4 varianti di colore: azzurro, beige, rosa, bianco.

EN 12L rigid cooler bag. Suitable for keeping food and drinks cool. Equipped with a rigid handle and adjustable shoulder strap, interchangeable according to your needs. Its lid can also be used as a drink tray. Available in 4 color variants: light blue, beige, pink, white.

FR Sac isotherme rigide de 12L. Idéal pour conserver au frais les aliments et les boissons. Équipé d'une poignée rigide et d'une bandoulière réglable, interchangeables selon vos besoins. Son couvercle peut également être utilisé comme plateau pour les boissons. Disponible en 4 variantes de couleurs : bleu clair, beige, rose, blanc.



WD735AZZ



WD735B



WD735BE



WD735RO

*Tracolla regolabile!
Adjustable shoulder!
Bandoulière réglable!*

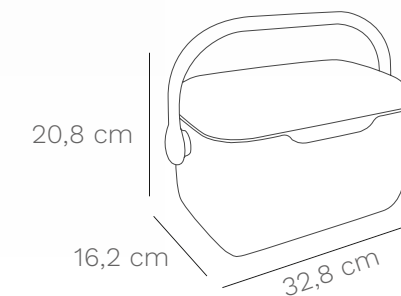

MALIBÙ LINE



WD661AR



WD661BL



WD661BE



WD661V

*Con interno decorato!
With decorated interior!
Avec intérieur décoré!*



WD661

IT Borsa termica premium cooler 25L.

Colorata e capiente, un accessorio indispensabile per le tue attività outdoor. Disponibile in 4 varianti di colore: arancio e petrolio, blu e bianco, beige e marrone, verde e marrone.

EN Premium cooler bag, 25L capacity. Colorful and roomy, an essential accessory for your outdoor activities. Available in 4 color variants: orange and petrol, blue and white, beige and brown, green and light blue.

FR Sac isotherme premium cooler de 25L. Coloré et spacieux, un accessoire indispensable pour vos activités en plein air. Disponible en 4 variantes de couleurs: orange et pétrole, bleu et blanc, beige et marron, vert et bleu clair.

 Non lavare
Don't wash
Ne pas laver

 Non stirare
Don't iron
Ne pas repasser

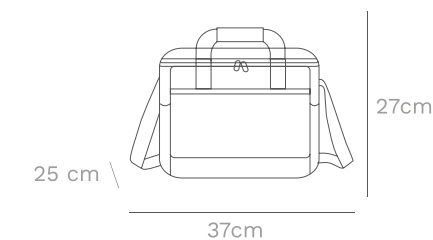



WD662AR



WD662BL



WD662BE



WD662V

*Con interno decorato!
With decorated interior!
Avec intérieur décoré!*

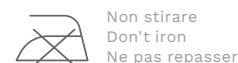

WD662

IT Borsa termica modello Tote 20L.

Perfetta per i tuoi pranzi all'aperto, comoda e pratica, per vivere le tue gite fuori porta con stile. Disponibile in 4 varianti di colore: arancio e petrolio, blu e bianco, beige e marrone, verde e azzurro.

EN Thermal bag Tote model, 20L capacity. Perfect for your outdoor lunches, comfortable and practical, to live your excursions with style. Available in 4 color variants: orange and petrol, blue and white, beige and brown, green and light blue.

FR Sac isotherme modèle Tote de 20L. Parfait pour vos repas en plein air, confortable et pratique, pour vivre vos sorties avec style. Disponible en 4 variantes de couleurs: orange et pétrole, bleu et blanc, beige et marron, vert et bleu clair.



WD663AR



WD663BL



WD663BE



WD663V

WD663

IT Lunch bag termica grande 10L.

Comoda e spaziosa, perfetta per contenere i tuoi cibi preferiti e le bevande nelle tue escursioni fuori porta. Disponibile in 4 varianti di colore: arancio e petrolio, blu e bianco, beige e marrone, verde e azzurro.

EN Large thermal lunch bag, 10L capacity. Comfortable and spacious, perfect for holding your favorite foods and drinks on your excursions. Available in 4 color variants: orange and petrol, blue and white, beige and brown, green and light blue.

FR Grand sac à lunch isotherme de 10L. Confortable et spacieux, parfait pour contenir vos aliments et boissons préférés lors de vos excursions. Disponible en 4 variantes de couleurs: orange et pétrole, bleu et blanc, beige et marron, vert et bleu clair.



WD664AR



WD664BL



WD664BE



WD664V

WD664

IT Lunch bag termica piccola 6L.

Grazie alle dimensioni ridotte è perfetta per i tuoi pranzi all'aperto, al lavoro o in spiaggia. Disponibile in 4 varianti di colore: arancio e petrolio, blu e bianco, beige e marrone, verde e azzurro.

EN Small thermal lunch bag, 6L capacity. Thanks to its small size it is perfect for your outdoor lunches, at work or at the beach. Available in 4 color variants: orange and petrol, blue and white, beige and brown, green and light blue.

FR Petit sac à lunch thermique de 6L. Grâce à sa petite taille, il est parfait pour vos repas en plein air, au travail ou à la plage. Disponible en 4 variantes de couleurs: orange et pétrole, bleu et blanc, beige et marron, vert et bleu clair.

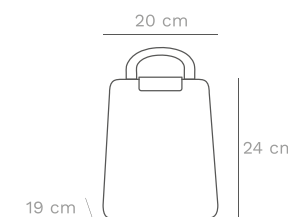



WD665AR



WD665BL



WD665BE



WD665V

WD665

IT Pochette termica con zip.

Accessorio comodo ed originale per vivere con stile le tue giornate outdoor. Disponibile in 4 varianti di colore: arancio e petrolio, blu e bianco, beige e marrone, verde e azzurro.

EN Thermal clutch bag with zip. Comfortable and original accessory, to give your outdoor days a touch of style. Available in 4 color variants: orange and petrol, blue and white, beige and brown, green and light blue.

FR Pochette thermique avec zip. Accessoire confortable et original pour vivre avec style vos journées en plein air. Disponible en 4 variantes de couleurs: orange et pétrole, bleu et blanc, beige et marron, vert et bleu clair.



Non lavare
Don't wash
Ne pas laver



Non stirare
Don't iron
Ne pas repasser

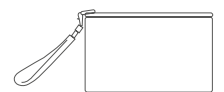

20 cm

28,5 cm





WD666AR



WD666BL



WD666BE



WD666V

WD666

IT Zaino impermeabile 20L.

Un articolo moderno ed originale che darà alle tue avventure un tocco di colore ed originalità. Disponibile in 4 varianti di colore: arancio e petrolio, blu e bianco, beige e marrone, verde e azzurro.

EN Waterproof backpack, 20L capacity. A modern and original article that will allow you to keep your devices safe and that will give your adventures a touch of color and originality. Available in 4 color variants: orange and petrol, blue and white, beige and brown, green and light blue.

FR Sac à dos étanche de 20L. Un article moderne et original qui vous permettra de garder vos appareils en sécurité et qui donnera à vos aventures une touche de couleur et d'originalité. Disponible en 4 variantes de couleurs: orange et pétrole, bleu et blanc, beige et marron, vert et bleu clair.

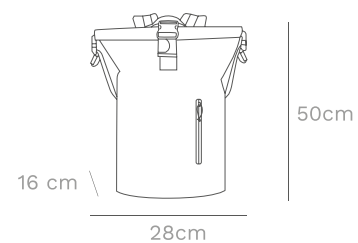

WD667AR



WD667BL



WD667BE



WD667V

WD667

IT Sacco impermeabile con cinghia regolabile 10L.

Il posto perfetto per tenere i tuoi device al sicuro dall'acqua. Un accessorio indispensabile per le tue giornate in spiaggia o a bordo piscina. Disponibile in 4 varianti di colore: arancio e petrolio, blu e bianco, beige e marrone, verde e azzurro.

EN Waterproof bag with adjustable strap, 10L capacity. The perfect place to keep your devices safe from water. An essential accessory for your days at the beach or by the pool. Available in 4 color variants: orange and petrol, blue and white, beige and brown, green and light blue.

FR Sac étanche avec sangle réglable. L'endroit idéal pour garder vos appareils à l'abri de l'eau. Un accessoire indispensable pour vos journées à la plage ou au bord de la piscine. Capacité 10L. Disponible en 4 variantes de couleurs: orange et pétrole, bleu et blanc, beige et marron, vert et bleu clair.

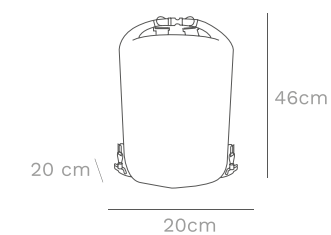



WD669AR



WD669BE



WD669BL



WD669V

WD669

IT Telo mare 100% cotone.

Dai colori moderni, morbido e super leggero. Perfetto per le tue giornate estive. Disponibile in 4 varianti di colore: arancio e petrolio, blu e bianco, beige e marrone, verde e azzurro.

EN 100% cotton beach towel. Modern colors, soft and super light. Perfect for your summer days. Available in 4 color variants: orange and petrol, blue and white, beige and brown, green and light blue.

FR Serviette de plage 100% Coton. Aux couleurs modernes, elle est douce et super légère. Parfait pour vos journées d'été. Disponible en 4 variantes de couleurs: orange et pétrole, bleu et blanc, beige et marron, vert et bleu clair.

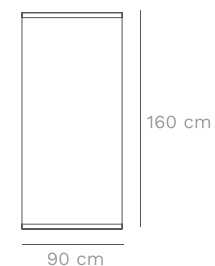

WD670

IT Ventaglio.

Un accessorio colorato ed originale che rinfrescherà le giornate più calde. Comodo per il tempo libero e le attività outdoor preferite dell'estate! Disponibile in 8 decori.

EN Fan. A colorful and original accessory that will refresh you in the hottest days. Convenient for leisure and summer outdoor activities! Available in 8 patterns.

FR Éventail. Un accessoire coloré et original qui rafraîchira les journées les plus chaudes. Pratique pour les loisirs et les activités en plein air de l'été! Disponible en 8 décors.



ESP004

Espositore da banco in cartone, ideale per 8 confezioni di ventagli.

Carton display, suitable for 8 folding fan packs. Présentoir de comptoir en carton, conçu pour présenter 8 éventails



WD670AR



WD670PET



WD670BL



WD670B



WD670M



WD670BE



WD670V



WD670AZ

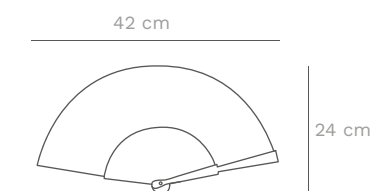

MIAMI LINE



ESP001

IT Espositore in legno a 4 ripiani, ideale per bottigliette e altri articoli WD.

EN Wooden display, 4 layers, suitable for bottles and others WD products.

FR Présentoir en bois avec 4 étagères, idéal pour les bouteilles et autres articles WD

ESP002

Espositore da banco in cartone, ideale per 6 bottigliette.
Carton display, suitable for 6 bottles.

Présentoir de comptoir en carton, idéal pour 6 bouteilles.



Senza PIOMBO
LEAD free
Sans PLOMB



Sottovuoto
Vacuum
Sous vide

Senza BISFENOLO
Bisphenol free
Sans bisphénol



Doppia camera
Double wall
Double paroi

Certificazione FSC sui pack
FSC certification on packs
Certification FSC sur les emballages



Mantiene fino a 12h di caldo
Hot for up to 12h
Conserve la chaleur jusqu'à 12 heures

Acciaio INOX e rivestimento interno in rame
Stainless steel and internal copper coating
Acier inoxydable et revêtement intérieur en cuivre



Mantiene fino a 24h di freddo
Cold for up to 24h
Conserve le froid jusqu'à 24 heures

400 ml



WD506CAL



WD506LET



WD506MAN



WD506SQU



WD506ME



WD506CO



WD506BL



WD506AR

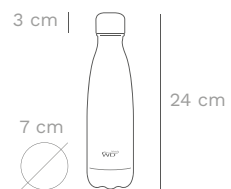

Lavare a mano
Hand wash
Lavage des mains

WD506

IT Bottiglia termica da 400ml in acciaio a doppia parete in diversi colori e fantasie.

EN Thermos 400ml. in stainless steel thermos in different colors and prints.

FR Bouteille isotherme de 400ml en acier à double paroi, disponible en plusieurs couleurs et motifs.



500 ml



WD365AZ WD365BA WD365CO WD365GC WD365RO WD365SA

500 ml



WD365F WD365 MAGENTA WD365LILLA WD365CE WD365 PETROLIO WD365BL



WD365V WD365LIME WD365GI WD365 MANDARINO WD365AR WD365R



WD365B WD365 SILVER WD365N WD365G WD365NOTTE

WD365

IT 0,5L bottiglia termica in acciaio a doppia parete in diversi colori e decori.

EN 0,5L thermos stainless steel double wall bottle in different colors and decors.

FR Bouteille isotherme de 0,5L en acier à double paroi, disponible en plusieurs couleurs et décors.



Lavare a mano
Hand wash
Lavage des mains

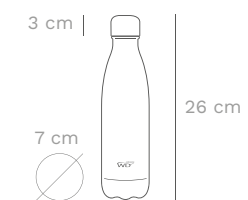

500 ml



WD365
COR



WD365
PES



WD365
COS



WD365
BEA



WD365
GIR



WD365
PAP



WD365
SUS

500 ml



WD365
PAVONE



WD365
TAT



WD365
FOGLIE



WD365
TIG



WD365
ZEB



WD365
UCC



WD365
CANI



WD365
GATTI



WD365
APE



WD365
ARA



WD365
FIO



WD365
FRU



WD365
JUNGLE



WD365
MAIO



WD365
MANDALA



WD365
MESSICO



WD365
ONDA



Lavare a mano
Hand wash
Lavage des mains



WD474GI WD474G WD474PET WD474MAT WD474OL



WD474N WD474B WD474R WD474BL

750 ml

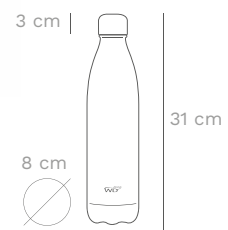

WD474

IT 0,75L bottiglia termica in acciaio a doppia parete disponibile in diversi colori.

EN 0,75L thermos stainless steel double wall bottle available in different colors.

FR Bouteille isotherme de 0,75L en acier à double paroi, disponible en plusieurs couleurs.

1 litro



WD575CO WD575V WD575AZ WD575LIL WD575TER WD575ANT

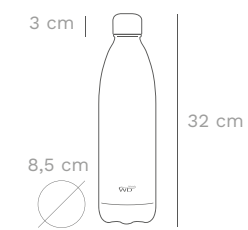

WD575

IT 1L bottiglia termica in acciaio a doppia parete disponibile in diversi colori.

EN 1L thermos stainless steel double wall bottle available in four different colors.

FR Bouteille isotherme de 1L en acier à double paroi, disponible en quatre couleurs différentes.



WD535

IT Cover termica in neoprene che protegge la tua bottiglietta termica dagli urti e ne aumenta la capacità termica. Un accessorio unico che veste e cambia il look della tua bottiglietta WD365 senza comprometterne la leggerezza. Adatto per bottiglia da 500 ml. Imballo singolo, inner da 6 pz assortiti.

EN Neoprene thermic cover which protects your WD365 bottle from damage and shock, while enhancing its thermal capacity. An accessory that can change the look of your WD365 bottle without affecting its lightness. Compatibility for a 16.9 fl oz bottle. Single pack, inner with 6 assorted pcs.

FR Set de 6 Housses de protection en Néoprène isotherme. Cette housse protège votre bouteille isotherme (bouteille WD365, 500ml) des chocs, augmente son pouvoir de conservation du chaud ou du froid et en change son look. Set de 6 housses de couleurs différentes vendu par carton.

Lavabile a 30°
Washable at 30°
Lavable à 30°

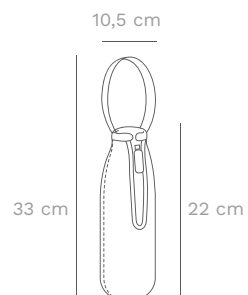

WD365KIT

IT Set per Bottiglia termica WD365 e WD506.

Il kit è composto da:

- Scovolino in fibra naturale e manico in legno ideale per pulire internamente la tua bottiglia;
- Tappo sport & leisure con cannuccia per le tue attività sportive;
- Gancio universale con moschettone per appendere la tua bottiglietta allo zaino, alla cintura o alla tua borsa;

EN Set for thermos bottle WD365 and WD506. The kit is composed of:

- Brush in natural fiber and wooden handle, ideal for cleaning your bottle internally;
- Sport & leisure top/lid with straw for your sports activities;
- Universal hook with snap hook to hang your bottle on your backpack, belt or any other bag;

FR Le kit se compose de:

- Brosse en fibres naturelles et manche en bois idéale pour nettoyer l'intérieur de votre bouteille;
- Bouchon sport & loisirs avec paille pour vos activités sportives;
- Mousqueton universel avec mousqueton pour accrocher votre bouteille à votre sac à dos, votre ceinture ou votre sac;

Set for thermos bottle WD365 and WD506. The kit is composed of:

- Brush in natural fiber and wooden handle, ideal for cleaning your bottle internally;
- Sport & leisure top/lid with straw for your sports activities;
- Universal hook with snap hook to hang your bottle on your backpack, belt or any other bag



No lavastoviglie
No dishwasher
Pas de lave-vaisselle

No microonde
Nomicrowave
Pas de micro-ondes

WD550

IT Tappo smart.

Con un tocco sul display, comparirà la temperatura della bevanda contenuta all'interno della tua bottiglia. La temperatura potrà essere facilmente controllata anche attraverso il colore della goccia presente sul display: goccia blu = liquido freddo. Goccia verde = liquido adatto alla consumazione. Goccia rossa = liquido caldo. Durata batteria circa 2 anni (o 50.000 visualizzazioni). Compatibili solo con le bottiglie WD365 e WD506.

EN Smart lid. With a simple tap, the temperature of the drink in your bottle will appear on the display. The temperature can be also easily checked through the color of the drop on the display: blue drop = cold liquid. Green drop = liquid suitable for consumption. Red drop: = hot liquid. Battery life approximately 2 years (or 50,000 views). Compatible with WD365 and WD506 bottles only.

FR Bouchon intelligent. D'une simple pression sur l'écran, la température de la boisson contenue dans votre bouteille s'affiche. La température peut également être facilement contrôlée par la couleur de la goutte sur l'écran: goutte bleue = liquide froid. Goutte verte = liquide propre à la consommation. Goutte rouge = liquide chaud. Durée de vie des piles: environ 2 ans (ou 50 000 affichages). Compatible uniquement avec les bouteilles WD365 et WD506.

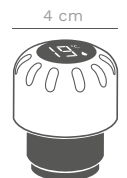
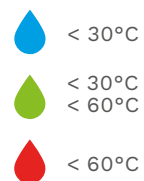

Compatibile solo con WD365 e WD506
Compatible only with WD365 and WD506
Compatible uniquement avec WD365 et WD506



No microonde
Nomicrowave
Pas de micro-ondes



No lavastoviglie
No dishwasher
Pas de lave-vaisselle

WD518

IT Moschettone con anello in silicone colorato.

Display da banco da 50 pz. Colori assortiti.

EN Snap hook with colored silicone ring. Display with 50 pcs. Assorted colors.

FR Mousqueton avec anneau en silicone coloré.

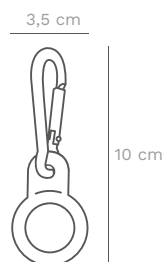

WD555
MAGENTA



WD555
MANDARINO



WD555
LIME



WD555BL



WD555N



WD555

IT Lunch box termica da 530ml.

Pratica per portare ovunque con te i tuoi cibi preferiti. Lo scomparto all'interno del tappo svitabile può essere usato come portasalse/spezie/muesli ed è dotato di un pratico cucchiaino pieghevole. Corpo interno e cucchiaino pieghevole in acciaio INOX304, gancio esterno in silicone.

EN 530ml Thermic lunch box. Practical for carrying your favourite food wherever you go. The twist-off lid can be used as a sauce/spices/muesli holder and is equipped with a folding spoon. Internal body and foldable spoon in SS304, external hook in silicone.

FR Lunch box isotherme de 530ml. Pratique pour emporter vos aliments préférés partout avec vous. Le compartiment à l'intérieur du bouchon dévissable peut être utilisé comme porte-sauce/épices/muesli et dispose d'une cuillère pliante pratique. Corps intérieur et cuillère pliante en acier inoxydable INOX304, crochet extérieur en silicone.



Lavare a mano
Hand wash
Lavage des mains

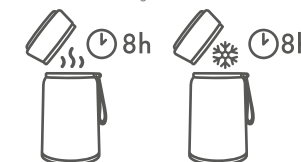

530ml



15,5 cm



WD570B



WD570BL



WD570R

WD570

IT Lunch box termica da 800ml.

Pratica per portare ovunque con te i tuoi cibi preferiti. Caldo fino a 8h, freddo fino a 8h. Lo scomparto all'interno del tappo svitabile può essere usato come portasalse/spezie/muesli ed è dotato di un pratico cucchiaino pieghevole. Corpo interno e cucchiaino pieghevole in acciaio INOX304, gancio esterno in silicone.

EN 800ml Thermic lunch box. Practical for taking always with you your favourite food. Hot for up to 8h, cold for up to 8 h. The unscrewable lid can be used as a sauce/spices/muesli holder and is equipped with a foldable spoon. Internal body and foldable spoon in SS304, external hook in silicone.

FR Lunch box isotherme de 800ml. Pratique pour emporter vos aliments préférés partout avec vous. Chaud jusqu'à 8h, froid jusqu'à 8h. Le compartiment à l'intérieur du bouchon dévissable peut être utilisé comme porte-sauce/épices/muesli et dispose d'une cuillère pliante pratique. Corps intérieur et cuillère pliante en acier inoxydable INOX304, crochet extérieur en silicone.



Lavare a mano
Hand wash
Lavage des mains

800ml

10 cm

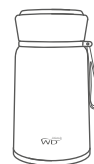

19,5 cm

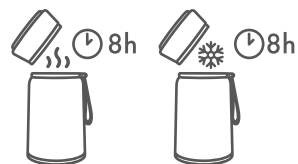

DOPPIA CAMERA
DOUBLE WALL
DOUBLE PAROI



SENZA BISFENOLO
WITHOUT BISPHENOL
SANS BISPHÉNOLO



SENZA PIOMBO
LEAD-FREE
SANS PLOMB



PACKAGING SOSTENIBILE
SUSTAINABLE PACKAGING
EMBALLAGE DURABLE



WD525B



WD525R



WD525
MANDARINO



TAPPO IN ACRILICO
ACRILIC LID
BOUCHON EN ACRYLIQUE



WD525
PETROLIO



WD525BL



TAPPO IN ACCIAIO INOX
STAINLESS STEEL LID
BOUCHON EN ACIER
INOXYDABLE

WD525

IT Mug termica da 310 ml in acciaio INOX a doppia parete e **2 tappi intercambiabili**, di cui uno in acciaio per uso ufficio "ready to use", e uno in acrilico "take away".

EN Thermic mug 310ml. in stainless steel double wall and 2 interchangeable lids, one in stainless steel for office use 'ready to use', and the other in acrylic with slide closure 'take away'.

FR Mug isotherme double paroi. Contenance: 310ml. Acier inoxydable double paroi. 2 bouchons interchangeables: 1 en acier et 1 en acrylique.



Lavare a mano
Hand wash
Lavage des mains



DOPPIA CAMERA
DOUBLE WALL
DOUBLE PAROI



SENZA BISFENOLO
WITHOUT BISPHENOL
SANS BISPHÉNOLO



SENZA PIOMBO
LEAD-FREE
SANS PLOMB



PACKAGING SOSTENIBILE
SUSTAINABLE PACKAGING
EMBALLAGE DURABLE

8,5 cm



12 cm



WD618V

WD618AZ

WD618GI

WD618

IT Lunch Box colorata con coperchio decorato e borsetta termica coordinata.

Composta da: 2 contenitori sovrapponibili, 1 coperchio, 2 separatori, 3 posate in ABS (coltello, forchetta, cucchiaio) ed elastico per mantenere ermeticamente chiusi i contenitori. Kit molto pratico per scaldare i cibi in microonde durante la pausa pranzo o per un pic-nic all'aria aperta.

EN Colored Lunch Box with decorated lid. Composed of: 2 stackable cases, one lid, 2 separators, 3 ABS cutlery (knife, fork, spoon) and an elastic band for hermetic closure. Very practical to heat your lunch in the microwave or for a pic-nic at the park.

FR Lunch box colorée avec couvercle décoré et sac isotherme assorti. Composé de: 2 récipients empilables, 1 couvercle, 2 séparateurs, 3 couverts en ABS (couteau, fourchette, cuillère) et un élastique pour maintenir les récipients hermétiquement fermés. Kit très pratique pour réchauffer des aliments au micro-ondes pendant la pause déjeuner ou pour un pique-nique en plein air.

LUNCH BOX



Si lavastoviglie
Dishwasher safe
Lave-vaisselle possible



Si microonde
Microwave safe
Micro-ondes possible

BORSA | BAG | SAC



Non lavare
Don't wash
Ne pas laver



Non stirare
Don't iron
Ne pas repasser



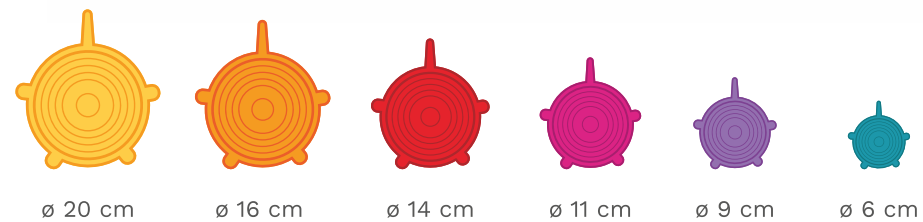

WD569

IT Set composto da sei coperchi salvafreschezza in silicone.

Perfetto come coperchio per contenitori e per conservare i tuoi cibi. Conserva i tuoi cibi e le tue bevande, utilizzali come cover per barattoli, contenitori di vetro, frutta e verdura. Grazie alla loro eccellente flessibilità sono adattabili a varie misure e forme. Facili da pulire, poiché lavabili in lavastoviglie. Riutilizzali quante volte vuoi e aiuta il pianeta riducendo l'utilizzo delle pellicole plastiche.

EN Set composed by six food silicone caps. Perfect as a lid for containers and for storing your food. Store your food and drinks, use them as covers for jars, glass containers, fruit and vegetables. Thanks to their excellent flexibility they are adoptable to various sizes and shapes. Easy to clean, as they are dishwasher safe. Reuse them as many times as you want and help the environment by reducing the use of plastic films.

FR Lot de six couvercles de conservation silicone. Parfait comme couvercle pour les récipients. S'adapte à différentes tailles et formes. Facile à nettoyer, car lavable au lave-vaisselle. Réutilisable et aide à limiter l'utilisation de films plastiques.



Si lavastoviglie
Dishwasher safe
Lave-vaisselle possible



Si microonde
Microwave safe
Micro-ondes possible



No pellicola
No film
Pas de pellicule



Impermeabile
Waterproof
Étanche



Elastico
Elastic
Élastique



Sigilla
Seal
Scellant

OLIMPIA LINE



WD646RO



WD647AZ



WD648AR

IT Barattolo in vetro borosilicato con manico colorato ad anello.

Un articolo originale che dona colore e allegria alla tua cucina.

EN Jar made of borosilicate glass with a colored ring handle. An original item that brings color and joy to your kitchen.

FR Pot en verre borosilicate avec poignée colorée à anneau. Un article original qui donne de la couleur et de la gaieté à votre cuisine.



No microonde
Nomicrowave
Pas de micro-ondes



No lavastoviglie
No dishwasher
Pas de lave-vaisselle

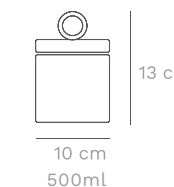
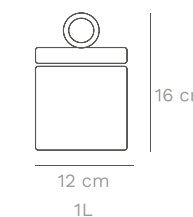
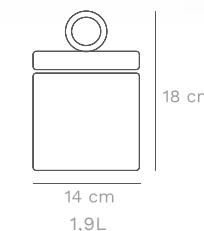

Capacità 800 ml.

Capacity 27 floz.

Contenance 800 ml.



WD649PE



WD649G

 No microonde
Nomicrowave
Pas de micro-ondes

 No lavastoviglie
No dishwasher
Pas de lave-vaisselle

WD649

IT Teiera in vetro borosilicato con manico colorato ad anello con filtro in acciaio inossidabile.

Il design moderno rende i tuoi momenti di relax unici ed originali. Capacità 800ml. Disponibile in 2 varianti di colore: petrolio e pesca, arancione e grigio.

EN Teapot made of borosilicate glass with colored ring handle with stainless steel filter. This modern design makes your moments of relaxation unique and original. Capacity 800ml. Available in 2 color variants: petrol and peach, orange and grey.

FR Théière en verre borosilicate avec poignée à anneau colorée avec filtre en acier inoxydable. Ce design moderne rend vos moments de détente uniques et originaux. Contenance 800ml. Disponible en 2 variantes de couleurs: pétrole et pêche, orange et gris.

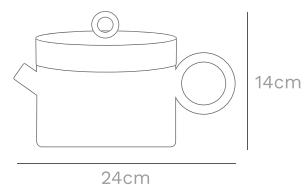

Capacità 1,2 L.
Capacity 40 fl.oz.
Contenance 1,2 L.



 Si lavastoviglie
Dishwasher safe
Lave-vaisselle possible

 Si microonde
Microwave safe
Micro-ondes possible

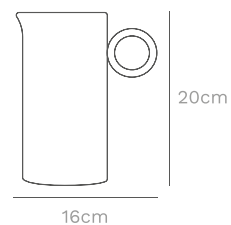

WD650V

IT Caraffa in vetro borosilicato con manico colorato ad anello. Perfetta per gustare le tue bevande preferite in qualsiasi momento. Capacità 1,2L. Manico verde.

EN Pitcher made of borosilicate glass with colored ring handle. Perfect for enjoying your favorite beverages at any time. Capacity 1,2L. Green handle.

FR Carafe en verre borosilicate avec poignée à anneau colorée. Parfait pour déguster vos boissons préférées à chaque occasion. Contenance 1,2L. Poignée verte.

Capacità 100 ml.
Capacity 3 fl.oz.
Contenance 100 ml.



 Si lavastoviglie
Dishwasher safe
Lave-vaisselle possible

 Si microonde
Microwave safe
Micro-ondes possible

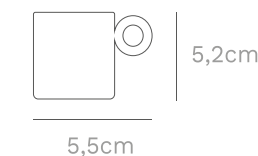

WD651

IT Set 6 tazze da caffè in vetro borosilicato con manico colorato ad anello.

Un assortimento adatto ad ogni occasione che donerà colore ed unicità alla tua tavola. Capacità 100ml. Manico colorato.

EN Set of 6 borosilicate glass coffee mugs with colored ring handle. This range is suitable for any occasion and it will bring color and uniqueness to your table 100ml. capacity. Colored handle.

FR Set de 6 tasses à café en verre borosilicate avec poignée annulaire colorée. Un assortiment adapté à chaque occasion qui apportera couleur et originalité à votre table. Contenance 100ml. Poignée colorée.



Capacità 100ml.
Capacity 100ml.
Contenance 100ml.



SUPPORTO | SUPPORT | SOUTIEN
 No lavastoviglie
 No dishwasher
 Pas de lave-vaisselle

TAZZE | CUP | TASSES
 Sì lavastoviglie
 Dishwasher safe
 Lave-vaisselle possible

 Sì microonde
 Microwave safe
 Micro-ondes possible

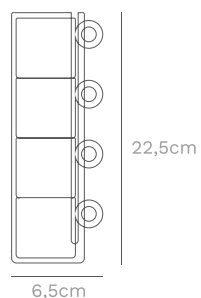

WD652

IT Set 4 tazze in vetro borosilicato con supporto in vetro borosilicato.

La forma moderna di queste tazze con manico ad anello le rende uniche ed originali, perfette per una pausa all'insegna del gusto e dello stile. Capacità 100ml. Disponibile in 4 varianti di colore: ambra, blu, grigio, bianco.

EN Set of 4 borosilicate glass mugs with borosilicate glass holder. The modern shape of these mugs with a ring handle makes them unique and original, perfect for a tasteful and stylish break 100ml. capacity. Available in 4 color variants: amber, blue, gray, white.

FR Set de 4 tasses en verre borosilicate avec porte-verre en verre borosilicate. La forme moderne de ces tasses avec une poignée en anneau les rend uniques et originales, parfaites pour une pause de bon goût et élégante. Contenance 100ml. Disponible en 4 variantes de couleurs: ambre, bleue, gris, blanc.

Capacità 300ml.
Capacity 300ml.
Contenance 300ml.



 Sì lavastoviglie
 Dishwasher safe
 Lave-vaisselle possible

 Sì microonde
 Microwave safe
 Micro-ondes possible

WD653

IT Set 4 tazze da tè in vetro borosilicato con manico colorato ad anello.

Perfette per godersi un momento di relax all'insegna del gusto e dello stile. Capacità 300ml. Manico colorato.

EN Set of 4 borosilicate glass teacups with colored ring handle. Perfect for enjoying a relaxing moment of taste and style 300ml. capacity. Colored handle.

FR Set de 4 tasses à thé en verre borosilicate avec poignée annulaire colorée. Parfait pour profiter d'un moment de détente avec goût et style. Contenance 300ml. Poignée colorée.

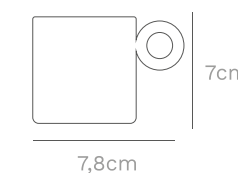

Capacità 350ml.

Capacity 350ml.

Contenance 350ml.

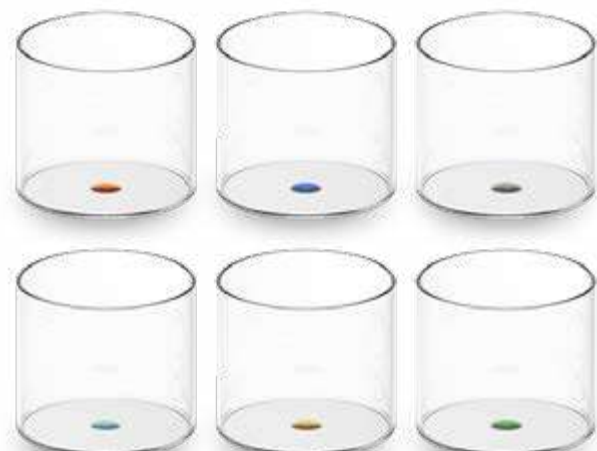

WD654

IT Set 6 bicchieri in vetro borosilicato.

Il particolare decoro ad anello renderà la tua tavola unica ed originale. Capacità 350ml.

EN Set of 6 borosilicate glass tumblers. The special ring decoration will make your table unique and original. Capacity 350ml.

FR Set de 6 verres en verre borosilicate. La décoration spéciale des anneaux rendra votre table unique et originale. Contenance 350ml.



Si lavastoviglie
Dishwasher safe
Lave-vaisselle possible



Si microonde
Microwave safe
Micro-ondes possible



7,3cm

8,3cm

Capacità 450ml.

Capacity 450ml.

Contenance 450ml.



WD655BL



WD655GI



WD655AM



WD655

IT Tisaniera con manico ad anello, filtro e tappo in vetro borosilicato.

Perfetta per la preparazione di tisane ed infusi, rendendo unico ed originale ogni tuo momento di relax. Capacità 450ml. Disponibile in 3 varianti di colore: blu, ambr, giallo.

EN Herbal tea pot with ring handle, filter and cap made of borosilicate glass. Perfect for preparing herbal teas and infusions, making every relaxing moment unique and original. 450ml. capacity. Available in 3 color variants: blue, amber, yellow.

FR Tisanière avec poignée annulaire, filtre et bouchon en verre borosilicate. Parfait pour préparer des tisanes et des infusions, rendant chaque moment de détente unique et original. Contenance 450ml. Disponible en 3 variantes de couleurs: bleu, ambre, jaune.



Si lavastoviglie
Dishwasher safe
Lave-vaisselle possible



Si microonde
Microwave safe
Micro-ondes possible

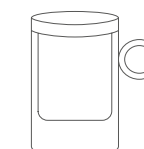

12cm

8cm

ACAPULCO LINE

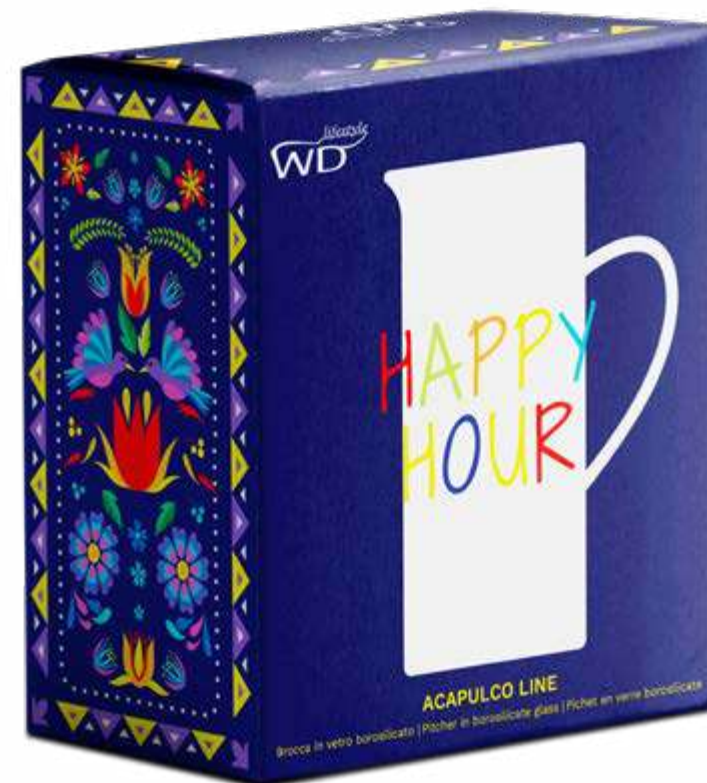

Handmade

WD635HAP

IT Brocca in vetro borosilicato con simpatica scritta in vetro colorato realizzata a mano. Capacità 1,2L.

EN Pitcher in borosilicate glass with with lettering in colored glass made by hand. Capacity 1,2L.

FR Pichet en verre borosilicate avec une inscription en verre coloré faite à la main. Capacité de 1,2L.



Si lavastoviglie
Dishwasher safe
Lave-vaisselle possible



Si microonde
Microwave safe
Micro-ondes possible

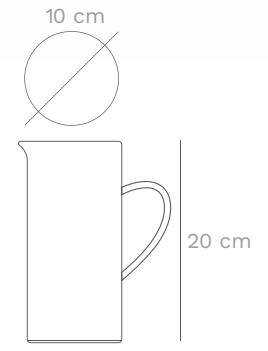



WD634BEE



WD634GIN



WD634MAR



WD634MOJ



WD634SAN



WD634SPR

WD634

IT Bicchiere da cocktail in vetro borosilicato con scritta decorativa in vetro colorato realizzata a mano. Capacità 450ml.

EN Cocktail glass in borosilicate glass with decorative lettering in colored glass made by hand. Capacity 450ml.

FR Verre à cocktail en verre borosilicaté avec inscription en verre teinté fabriqué à la main. Capacité 450ml.



Si lavastoviglie
Dishwasher safe
Lave-vaisselle possible



Si microonde
Microwave safe
Micro-ondes possible

9 cm



11 cm

7 cm





WD680

IT Set 6 cannucce riutilizzabili colorate in vetro borosilicato con scovolino per la pulizia.

Nel pieno rispetto dell'ambiente donano un tocco di colore ed allegria alle tue bevande, perfette per differenziare il proprio drink da quello degli altri. Colori rosa, verde, arancione, grigio, blu, giallo. Dimensione: Ø 0,80 cm H 20 cm.

EN Set of 6 reusable colored borosilicate glass straws with cleaning brush. In full respect of the environment, they give a touch of color and joy to your drinks, differentiating them from others. Colors: pink, green, orange, gray, blue, yellow. Size: 0.80 cm H 20 cm.

FR Set de 6 pailles colorées réutilisables en verre borosilicate avec brosette de nettoyage. En respectant pleinement l'environnement, elles donnent une touche de couleur et de joie à vos boissons, en différenciant votre boisson de celle des autres. Couleurs: rose, vert, orange, gris, bleu, jaune. Taille: 0,80 cm H 20 cm.



Si lavastoviglie
Dishwasher safe
Lave-vaisselle possible

HONG KONG LINE



WD658

IT Bilancia digitale colorata ultraslim.

Il design moderno e colorato dona originalità alla tua cucina. La bilancia di precisione misura oltre al peso (due unità di peso g e libbre convertibili), anche il volume dell'acqua e del latte (due unità di misura convertibili ml e fl oz). Sensibilità al grammo (1g) con portata massima di 10kg. Disponibile in 4 varianti colore: arancione, giallo, azzurro, blu scuro. Dimensioni: 21.0x16.0x1.9cm.

EN Digital scale, colorful and ultraslim. This modern and colorful design gives originality to your kitchen. The precision balance measures both the weight (two units of weight g and pounds, convertible) and the volume of water and milk (two units of measurement ml and fl oz, convertible). Gram sensitivity (1g) with a maximum load of 10kg. Available in 4 colours: orange, green, red, blue. Dimensions: 21.0x16.0x1.9cm

FR Balance numérique colorée ultraslim. Le design moderne et coloré donne de l'originalité à votre cuisine. La balance de précision mesure non seulement le poids (deux unités de poids g et livres convertibles), mais aussi le volume de l'eau et du lait (deux unités de mesure convertibles ml et fl oz). Sensibilité au gramme (1g) avec charge maximale de 10kg. Disponible en 4 couleurs: orange, jaune, bleu clair, bleu foncé. Taille: 21.0x16.0x1.9cm.

- T** Modalità tara / Mode tare
- W** Modalità volume acqua / Water volume mode / Mode volume d'eau
- M** Modalità volume latte / Milk volume mode / Mode volume de lait
- IP67** PROTEZIONE IP67 / Protezione dalla polvere e dall'acqua / IP67 PROTECTION / protection from dust and water splashes / PROTECTION IP67 / contre la poussière et les projections d'eau
- USB** •Ricaricabile con entrata USB / Tempo di ricarica 2h / •Rechargeable with usb input / Charging time 2h / •Rechargeable avec entrée USB / Temps de recharge 2h
- MAX 10 kg** MAX 10 kg / déchets de 1 g
- Impermeabile** Impermeabile / Waterproof / Imperméable

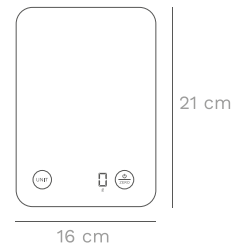

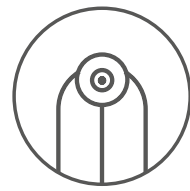

Compatta e pensile!
Compact and hanging!
Compact et suspendu !



WD659AR

WD659VE

WD659RO

WD659AZ

WD659

IT Bilancia digitale compatta.

Il design moderno e colorato dona originalità alla tua cucina. La bilancia di precisione misura sia il peso (due unità di peso g e libbre convertibili) sia il volume di acqua e latte (due unità di misura convertibili ml e fl oz). Sensibilità al grammo (1g) con portata massima di 5Kg. Disponibile in 4 varianti di colore: arancione, verde, rosso, azzurro. Dimensioni: 23.0x7.5cm.

EN Compact digital scale. This modern and colorful design gives originality to your kitchen. The precision balance measures both the weight (two units of weight g and pounds, convertible) and the volume of water and milk (two units of measurement ml and fl oz, convertible). Gram sensitivity (1g) with a maximum load of 5kg. Available in 4 colours: orange, green, red, blue. Dimensions: 23.0x7.5cm.

FR Balance numérique compacte. Le design moderne et coloré donne de l'originalité à votre cuisine. La balance de précision mesure à la fois le poids (deux unités de poids g et livres convertibles) et le volume d'eau et de lait (deux unités de mesure convertibles ml et fl oz). Sensibilité au gramme (1g) avec charge maximale de 5kg. Disponible en 4 couleurs: orange, vert, rouge, bleu clair. Taille: 23.0x7.5cm.



Modalità tara
 Mode tare



MAX 5 kg
 déchets de 5 kg



Modalità volume acqua
 Water volume mode
 Mode volume d'eau



Modalità volume latte
 Milk volume mode
 Mode volume de lait

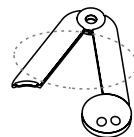

Zona di pesatura
 Weighing area
 Zone de pesage effective



1500 mAh battery

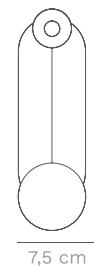

23 cm

7,5 cm



NEW YORK LINE



WD405AM



WD405V



WD405T



WD405R



WD405TR

WD405

IT Bottiglia colorata in acrilico 1L.

Decorazione verticale a rilievo effetto vetro. Disponibile in 8 varianti di colore: ambra, verde, turchese, rosso, trasparente, avio, marrone e blu.

EN Colored acrylic bottle 1L. Embossed vertical decoration with glass effect. Available in 8 color variants: amber, green, turquoise, purple, red, transparent, avio, marrone and blu.

FR Bouteille colorée avec stris en acrylique 1L. Décoration verticale en relief effet verre. Disponible en 8 variantes de couleurs: ambre, vert, turquoise, rouge, transparent, avio, marrone et blu.



No lavastoviglie
No dishwasher
Pas de lave-vaisselle



No microonde
Nomicrowave
Pas de micro-ondes

9 cm



28 cm



WD405AVI



WD405M



WD405BL



WD406AM



WD406AVI



WD406BL



WD406M



WD406R



WD406TR



WD406T



WD406V

WD406

IT Set 2 bicchieri colorati in acrilico 370ml.

Decorazione verticale a rilievo effetto vetro. Disponibile in 8 varianti di colore: ambra, verde, turchese, rosso, trasparente, avio, marrone e blu

EN Set of 2 colored acrylic glasses 370ml. Embossed vertical decoration with glass effect. Available in 8 color variants: amber, green, turquoise, purple, red, transparent.

FR Set 2 gobelets colorés et striés en acrylique. Contenance: 370ml. Décoration verticale en relief effet de verre. Disponible en 8 variantes de couleurs: ambre, vert, turquoise, rouge, transparent, avio, marrone et blu.



No lavastoviglie
No dishwasher
Pas de lave-vaisselle



No microonde
Nomicrowave
Pas de micro-ondes

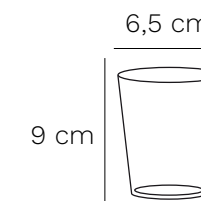



WD407AM



WD407AVI



WD407BL



WD407M

WD407

IT Brocca colorata in acrilico 2,3L.

Decorazione verticale a rilievo effetto vetro. Disponibile in 8 varianti di colore: ambra, verde, turchese, rosso, trasparente, avio, marrone e blu.

EN Colored acrylic pitcher 2,3L. Embossed vertical decoration with glass effect. Available in 8 color variants: amber, green, turquoise, purple, red, transparent, avio, marrone and blu.

FR Pichet coloré et strié en acrylique. Contenance: 2,3L. Décoration en relief vertical effet verre. Disponible en 8 variantes de couleurs: ambre, vert, turquoise, rouge, transparent, avio, marrone et blu.



WD407R



WD407T



WD407TR



WD407V



No lavastoviglie
No dishwasher
Pas de lave-vaisselle



No microonde
Nomicrowave
Pas de micro-ondes

15,5 cm



23,5 cm



WD408

IT Set 2 calici colorati in acrilico 460ml.

Decorazione verticale a rilievo effetto vetro. Disponibile in 8 varianti di colore: ambra, verde, turchese, rosso, trasparente, avio, marrone e blu.

EN Set of 2 colored acrylic goblets 460ml. Embossed vertical decoration with glass effect. Available in 8 color variants: amber, green, turquoise, purple, red, transparent, avio, marrone and blu.

FR Set de 2 verres à pied striés et colorés en acrylique. Contenance 460ml. Décoration verticale en relief effet verre. Disponible en 8 variantes de couleurs: ambre, vert, turquoise, rouge, transparent avio, marrone et blu.



WD408AM



WD408AVI



WD408T



WD408M



WD408R



WD408BL



WD408TR



WD408V

9,5 cm

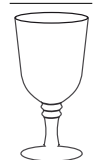

18 cm



No lavastoviglie
No dishwasher
Pas de lave-vaisselle



No microonde
Nomicrowave
Pas de micro-ondes



WD674

IT Set 6 bicchieri colorati in acrilico 370 ml.

Colori: ambra, vedre, turchese, marrone, rosso e blu. Decorazione verticale a rilievo effetto vetro.

EN Set of 6 colored acrylic glasses 370 ml. Colors: amber, green, turquoise, brown, red and blue. Embossed vertical decoration with glass effect.

FR Set 6 gobelets colorés et striés en acrylique. Contenance: 370 ml. Couleurs: ambre, vert, turquoise, marron, rouge et bleu. Décoration verticale en relief effet de verre.



No lavastoviglie
No dishwasher
Pas de lave-vaisselle



No microonde
Nomicrowave
Pas de micro-ondes

6,5 cm



9 cm



NEW YORK GOLD



WD405GOLD



WD406GOLD



WD407GOLD



WD408GOLD

WD405GOLD

IT Bottiglia in acrilico 1L. Decorazione verticale a rilievo effetto vetro con aggiunta finitura oro.

EN Acrylic bottle 1L. Embossed vertical decoration with glass effect and gold finishing.

FR Bouteille en acrylique de 1L. Décor vertical en relief, effet verre, avec finition dorée.



No microonde
Nomicrowave
Pas de micro-ondes



No lavastoviglie
No dishwasher
Pas de lave-vaisselle

WD406GOLD

IT Set 2 bicchieri in acrilico con finitura bordo oro 370ml. Decorazione verticale a rilievo effetto vetro.

EN Set of 2 acrylic glasses with gold finishing 370ml. Embossed vertical decoration with glass effect.

FR Set de 2 verres en acrylique avec finition en bordure dorée 370ml. Décoration verticale en relief avec effet verre.

WD407GOLD

IT Brocca in acrilico 2,3L. Decorazione verticale a rilievo effetto vetro con aggiunta finitura oro.

EN Acrylic Pitcher with glass effect and gold finishing 2,3L. Embossed vertical decoration with glass effect.

FR Carafe en acrylique de 2,3L. Décor vertical en relief effet verre avec finition dorée ajoutée.

WD408GOLD

IT Set 2 calici con bordo oro in acrilico con aggiunta finitura oro 460ml. Decorazione verticale a rilievo effetto vetro.

EN Set of 2 transparent goblets with glass effect and gold finishing 460ml. Embossed vertical decoration with glass effect.

FR Set de 2 verres à pied en acrylique bordés d'or 460 ml. Décoration verticale en relief effet verre.



DINER LAMP

Diner Lamp è ispirata ai locali tipici degli States. I Diner sono locali nati negli Stati Uniti nei primi anni '50 come tavola calda dove mangiare un boccone al volo. Ancora oggi appaiono ricchi di fascino e soprattutto, di storia e di storie. Tradizionalmente assomigliano al vagone di un treno, con dei lunghi banconi bar e dei tavoli divisi da separè. L'illuminazione di questi locali è parte fondamentale della loro atmosfera.

Diner Lamp is inspired by the typical States' diners. Diners were born in the United States in the early '50s like a place where to eat something quickly. Nowadays they still have a fascinating atmosphere and they are rich in history and stories to tell. Traditionally they look like a train passenger car, in which people sit at the counter or in the booths. The lighting of these diners is a fundamental part of their atmosphere.

Diner Lamp s'inspire des diners typiques des États-Unis. Les diners sont des lieux qui ont vu le jour aux États-Unis au début des années 1950 sous la forme de diners où l'on pouvait manger sur le pouce. Aujourd'hui encore, ils apparaissent pleins de charme et, surtout, d'histoire et d'histoires. Traditionnellement, ils ressemblent à un wagon de train, avec de longs comptoirs de bar et des tables divisées par des cloisons. L'éclairage de ces lieux est un élément fondamental de leur atmosphère.



WD537CA



WD537PA



WD537SEN



WD537MAT



WD537G



WD537PET



WD537B



WD537N

WD537 DINER LAMP



IT Lampada da tavolo portatile ricaricabile tramite entrata USB.

Con tre diverse potenze di luminosità, ad accensione touch immediata. Luce al LED. Durata alla potenza minima 50h, durata alla potenza massima 7h, tempo di ricarica 7h. La lampada può essere utilizzata sia all'interno che all'esterno grazie al grado di protezione IP54. Potenza: 7.5W.

EN Portable table lamp, rechargeable through USB cable. With three different brightness levels and touch switch. Led light. Battery lasts up to 50h at minimum level and up to 7h at maximum level. Charging time 7h. The lamp can be used inside and outside thanks to the protection rating IP54. Power: 7.5W.

FR Lampe de table sans fil et rechargeable. Ampoule LED de puissance 7.5W. Interrupteur tactile. Trois niveaux de luminosité. Recharge par prise type USB. Durée de la charge: 50h d'éclairage en puissance minimale et 7h d'éclairage en puissance maximale. Temps de recharge: 7h. Utilisation en intérieur et extérieur, norme IP54.



- Ricaricabile con entrata USB, alimentatore non incluso
- Rechargeable with USB input, power supply not included
- Rechargeable avec entrée USB, alimentation non incluse



- Luce LED/LED light/Lumière LED
- 3 diverse potenze di luminosità
- 3 different powers of brightness
- 3 pouvoirs de luminosité différents



- Accensione touch
- Turning touch
- Allumage par contact



- Durata potenza min 50h/max 7h
- Durée puissance min 50h/max 7h
- Power duration min 50h/max 7h



- PROTEZIONE IP54
- Protezione dalla polvere e dagli schizzi d'acqua
- IP54 PROTECTION
- protection from dust and water splashes
- PROTECTION IP54
- contre la poussière et les projections d'eau

Tempo di ricarica 7H

Charging time 7H

Temps de charge 7H



WD617GOLD



WD617SILVER

WD617 LOUNGE LAMP

IT Lampada da tavolo portatile ricaricabile, con luce a LED e sensore Gesture Control.

Disco decorativo in acciaio con finish spazzolato a raggiera. Dotata di sensore a infrarossi, al passaggio della mano ne recepisce il movimento e accende la lampada automaticamente. Soffermandosi su di esso sarà possibile regolarne la luminosità. Durata della batteria alla potenza minima 100h. Durata della batteria alla potenza massima 6h. Tempo di ricarica 3h. Potenza: 1W. Dimensioni: Ø16cm x 10cm.

EN Portable rechargeable table lamp with LED light and Gesture Control sensor. Decorative steel disc with brushed finish in a sunburst pattern. Equipped with an infrared sensor that detects the movement of a hand and turns the lamp on automatically. Hovering the hand above it will allow you to adjust its brightness. Battery lasts up to 100h at minimum level and up to 6h at maximum level. Charging time 3h. Power: 1W. Dimensions: Ø 16cm x 10cm.

FR Lampe d'ambiance sans fil et rechargeable avec éclairage par capteur de mouvement. Disque de couleur (Or ou Argent) en acier brossé. Ampoule LED de puissance 1W. Interrupteur par capteur infrarouge (détection de mouvement). Réglages du niveau de luminosité en maintenant la main proche du capteur infrarouge pendant un court moment. Recharge par prise type USB type-C. Durée de la charge: 100h d'éclairage en puissance minimale et 6h d'éclairage en puissance maximale. Temps de recharge: 3h. Dimension: Ø 16cm x hauteur 10cm.



Accendi la lampada con un semplice gesto della mano.

Turn on the lamp with a simple wave of your hand.

Allumez la lampe d'un simple geste de la main.



Puoi dimmerare la luce soffermandoti sul sensore.

You can dim the light by focusing on the sensor.

L'intensité lumineuse se règle par le maintien de la main proche du capteur.



Sensore Gesture Control
Capteur de contrôle gestuel
Gesture Control sensor



Luce LED
Lumière LED
LED light



Batteria a lunga durata
Long lasting battery
Batterie longue durée



Entrata USB tipo C
Entrée USB Type-C
Type-C port





Ideale per ricaricare 8 lampade contemporaneamente!
Ideal for charging 8 lamps at the same time!
Idéal pour recharger 8 lampes en même temps!



WD641

IT Caricatore Multiplo 8 porte USB (di cui 1 con tecnologia Quick Charger 3.0).

Con schermo a LED per visualizzare i dati di carica, dotato di presa.

EN 8 USB port charger (with 1 port in Quick Charger 3.0 technology), with LED display to check the charging data and plug.

FR Chargeur multiple 8 ports USB (dont 1 technologie Quick Charger 3.0) avec écran LED pour afficher les données de charge, équipé d'une prise de courant.

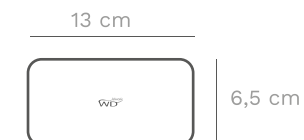

MILANO LINE



Tempo di ricarica 4-6H
Charging time 4-6H
Temps de charge 4-6H



Speaker Bluetooth
Bluetooth speaker



Luce dimmerabile
Dimmable light
Lumière à gradation



Cavo USB
USB cable
Cable USB



Controllo remoto
Remote control
Contrôle à distance



Secchiello ghiaccio
Wine cooler
Seau à glace



Luce LED 16 colori
16-color LED light
Lumière LED 16 couleurs



Resistente alla polvere
Resistant to dust
É tanche à la poussière



Luce ritmica
Rhythmic light
Lumière rythmique



Connessione simultanea
Connexion simultanée
Simultaneous connection

WD581 ROOFTOP

IT ROOFTOP è un secchiello ghiaccio con altoparlante Bluetooth e lampada LED.

La tecnologia Bluetooth ti consente di riprodurre la tua musica preferita mentre il tuo vino/le tue bevande si mantengono fresche e la luce LED crea un'atmosfera unica. Puoi utilizzarlo ovunque grazie alla batteria ricaricabile che lo rende portatile e alla protezione da acqua e polvere. Possibilità di connessione simultanea ad un altro ROOFTOP.

EN ROOFTOP is a Wine Cooler with Bluetooth speaker and LED lamp. Bluetooth technology allows you to play your favourite music, while your wine or drinks stay cool and the LED light creates a unique atmosphere. You can use it in any place thanks to the rechargeable battery which makes it portable and the protection from water and dust. It can be connected simultaneously to another ROOFTOP.

FR Diffuseur d'huile essentielle avec lumière d'ambiance. Il diffuse une fine brume aromatisée qui ne brûle pas les ingrédients naturels des huiles essentielles. Les 3 niveaux de luminosité permettent de créer des atmosphères agréables. Le diffuseur se recharge sur une prise USB.

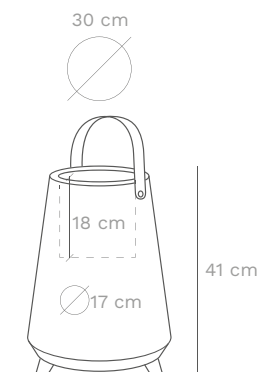



WD660TOR

WD660AVI

WD660MEL

WD660B

WD660N

WD660

IT Lampada da tavolo portatile ricaricabile tramite entrata USB.

Dotata di pulsante di accensione touch e luce dimmerabile da 5% a 100% di luminosità. Luce a LED alimentata da batteria al litio 1800mAh con durata a potenza massima di 6 ore, tempo di ricarica 4 ore. Utilizzabile anche in ambienti esterni, protezione IP44. Potenza 5.5W. Disponibile in 5 varianti di colore: tortora, avio, melone, bianco, nero.

EN Portable table lamp rechargeable via USB input. It features a touch power button and dimmable light from 5% to 100% brightness. LED light powered by 1800mAh lithium battery with maximum power life of 6 hours, charging time 4 hours. It can also be used outdoors, IP44 protection. Power 5.5W. Available in 5 color variants: dove, blue avio, melon, white, black.

FR Lampe de table portable et rechargeable via une entrée USB. Elle dispose d'un bouton d'alimentation tactile et lumière gradable de 5% à 100% de luminosité. La lumière LED est alimentée par batterie au lithium 1800mAh avec une durée maximale de 6 heures, temps de charge 4 heures. Utilisable aussi en extérieur, protection IP44. Puissance 5.5W. Disponible en 5 variantes de couleurs: couleur colombe, aviation, melon, blanc, noir.



- Ricaricabile con entrata USB alimentatore non incluso
- Rechargeable with usb input power supply not included
- Rechargeable avec entrée USB alimentation non incluse



- Luce LED/LED light/Lumière LED dimmerabile gradualmente
- gradually dimmable
- réglable progressivement



- Accensione touch
- Turning touch
- Allumage par contact



- Entrata USB tipo C
- Entrée USB Type-C
- Type-C port



- Durata potenza min 50h/max 6h
- Durée puissance min 50h/max 6h
- Power duration min 50h/max 6h



- PROTEZIONE IP44
- Protezione dalla polvere e dagli schizzi d'acqua

- IP44 PROTECTION
- protection from dust and water splashes

- PROTECTION IP44
- contre la poussière et les projections d'eau

Tempo di ricarica 4H
Charging time 4H
Temps de charge 4H





WD708N

WD708

IT Caminetto centrotavola o d'arredo.

Elegante e moderno, perfetto per donare calore all'atmosfera. Da utilizzare con bioetanolo, non crea vapori dannosi o odori spiacevoli. Bioetanolo non incluso. Utilizzabile sia all'interno sia all'esterno. Dimensioni: L 37 l 18 H 6 cm. Disponibile in 2 varianti di colore: nero, bianco.

EN Elegant and modern fireplace as centrepiece or ornamental, perfect for adding warmth to the atmosphere. To be used with bioethanol, it does not create harmful vapours or unpleasant odours. Suitable for both indoor and outdoor use. Dimensions: W 37 l 18 H 6 cm. Available in 2 colour variants: black, white.

FR Cheminée pièce maîtresse ou décorative élégante et moderne, parfaite pour ajouter de la chaleur à l'atmosphère. À utiliser avec du bioéthanol, ne crée pas de vapeurs nocives ou d'odeurs désagréables. Peut être utilisé à l'intérieur comme à l'extérieur. Dimensions: L 37 l 18 H 6 cm: L 37 l 18 H 6 cm. Disponible en 2 variantes de couleur: noir, blanc.



WD708B





Tempo di ricarica 6H
Charging time 6H
Temps de charge 6H



WD619B



WD619N

WD619

IT Speaker Bluetooth con funzione Power bank e luce a LED effetto lanterna dimmerabile.

Grazie alla cassa cilindrica, ascoltare musica diventerà un'esperienza audio a 360°. La gomma antiscivolo sulla base ti permette di posizionarlo in sicurezza ovunque. La porta USB ti consente di ricaricare il tuo dispositivo. Può riprodurre musica in maniera continua fino a 5h e illuminazione continua fino a 11h. Dimensioni: Ø 10,5x20cm.

EN Bluetooth speaker with Power bank function and dimmable lantern effect LED light. Thanks to the cylindrical speaker, listening to music will become a 360 ° audio experience. The non-slip rubber on the base allows you to place it safely anywhere. The USB port allows you to charge your device. It can play music continuously up to 5h and continuous lighting up to 11h. Size: Ø 10,5x20cm.

FR Lanterne Enceinte Bluetooth. Lumière LED chaude et fonction chargeur. Lanterne à Lumière LED chaude à intensité variable, puissance xW. La forme cylindrique haute permet une diffusion à 360° de la musique. L'embase du cylindre, équipé d'un caoutchouc anti-dérapant, permet de la placer en toute sécurité n'importe où. Un port USB vous permet de charger vos appareils. Durée de la charge: 5h de musique en continu et/ou 11h d'éclairage en continu. Dimension Ø 9 cm x hauteur 20 cm.

Bluetooth
V5.0 connection
(distanza di connessione ≥10m)
(receiving distance ≥10m)
(distance de connexion environ 10m)

Luce LED dimmerabile
Dimmable LED light
Intensité lumineuse réglable

Resistente all'acqua
Water resistant
Étanche

Ricaricabile
Rechargeable

Batteria 3600 mAh
3600 mAh battery
Batterie 3600 mAh
Power bank

Funzione Chiamata
Call function
Fonction Appel Téléphonique

Ingresso Aux
Aux input

Music a 360°
360° music

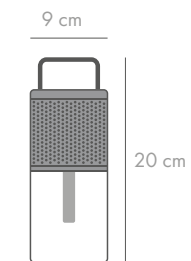

Vera pelle
Full grain leather
Cuir Véritable



WD574GOLD

WD574N

WD574SILVER

ESP006

Espositore da banco in cartone,
ideale per 1 Speaker.
Carton display,
suitable for 1 Speaker.
Carton display,
suitable for 1 Speaker.



Tempo di ricarica 3-4H
Charging time 3-4H
Temps de charge 3-4H

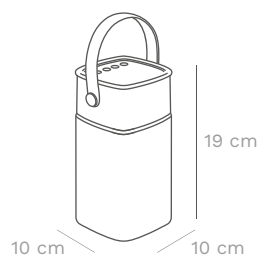

WD574 SKYLINE

IT Speaker Wireless con luce a LED.

Goditi un'esperienza audio tridimensionale grazie alla cassa a 360°. Compatto ma potente, questo speaker Bluetooth è dotato di una batteria performante che può riprodurre musica in maniera continua fino a 6-8h. 8 LED dimmerabili consentono di decidere l'intensità della luce.

EN Enjoy a three-dimensional audio experience thanks to the 360° speaker. Compact but powerful, this Bluetooth speaker is equipped with a high-performance battery that can play music continuously for up to 6-8h. The 8 dimmable LEDs allow you to decide the intensity of the light.

FR Haut-parleur sans fil avec lumière LED. Profitez d'une expérience audio tridimensionnelle grâce au haut-parleur à 360°. Compacte mais puissante, cette enceinte Bluetooth est dotée d'une batterie haute performance qui peut diffuser de la musique en continu pendant 6-8 heures. 8 LEDs à intensité variable vous permettent de décider de l'intensité de la lumière.



Bluetooth
V5.0 connection
(distanza di connessione ≥10m)
(receiving distance ≥10m)
(distance de connexion environ 10m)

Luce LED dimmerabile
Dimmable LED light
Intensité lumineuse réglable

Resistente all'acqua
Water resistant
Étanche

Ricaricabile
Rechargeable

Batteria 2000 mAh
2000 mAh battery
Batterie 2000 mAh

Funzione chiamata
Call function
Fonction Appel Téléphonique

Ingresso Aux
Aux input

Musica a 360°
360° music



WD628N



WD628B



Plastique
recyclé
Recycled
plastic



Non lavare
Don't wash
Ne pas laver



Non stirare
Don't iron
Ne pas repasser

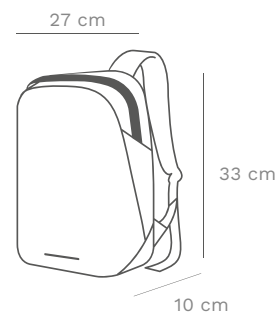

WD628

IT Zaino City Life Sling monospalla, ideale per la vita urbana e Hi-tech.

Ideato per tutti coloro che trascorrono la maggior parte del tempo fuori casa per studio o per lavoro. Completamente impermeabile grazie al tessuto e alle zip idrorepellenti. Tessuto esterno realizzato con plastica riciclata. Dotato di numerosi scomparti, tasca antifurto e inserti riflettenti. Scomparto Tablet: 30x22cm. Litraggio: 7L. Dimensioni: 23x34x12cm. Disponibile in 2 varianti colore: nero, nero e bianco.

EN Backpack City Life Sling one shoulder, ideal for urban and Hi-tech life. Designed for all those who spend most of their time away from home for study or work. Completely waterproof thanks to the water repellent fabric and zips. External fabric made with recycled plastic. Equipped with numerous compartments, anti-theft pocket and reflective inserts. Tablet compartment: 30x22cm. Capacity: 7L. Dimensions: 23x34x12cm. Available in 2 color variants: black, black and white.

FR Sac à dos City Life Sling une épaule, idéal pour la vie HI-TECH. Conçu pour tous ceux qui passent la plupart de leur temps hors de chez eux à étudier ou à travailler. Totalement imperméable grâce au tissu et aux fermetures à glissière hydrofuges. Tissu extérieur fabriqué en plastique recyclé. Équipé de nombreux compartiments, d'une pochette antivol et d'inserts réfléchissants. Compartiment pour tablette: 30x22cm. Contenance 7L. Dimension: 23x34x12cm. Disponible en 2 variantes de couleurs: noir, noir et blanc.





WD629N



WD629BE



WD629BL



Plastique
recyclé
Recycled
plastic



Non lavare
Don't wash
Ne pas laver



Non stirare
Don't iron
Ne pas repasser

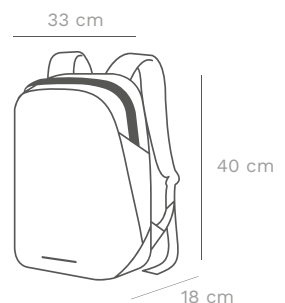

WD629

IT Zaino City Life Compact, ideale per la vita urbana e Hi-tech.

Ideato per tutti coloro che trascorrono la maggior parte del tempo fuori casa per studio o per lavoro. Completamente impermeabile grazie al tessuto e alle zip idrorepellenti. Tessuto esterno realizzato con plastica riciclata. Dotato di numerosi scomparti, tasca antifurto e inserti riflettenti. Scomparto Laptop (fino a 13"): 28x26cm. Scomparto Tablet: 30x22cm. Litraggio: 12L. Dimensioni: 28x39x13cm. Disponibile in 2 varianti colore: nero, nero e beige, nero e blu.

EN Backpack City Life Compact, ideal for urban and Hi-tech life. Designed for all those who spend most of their time away from home for study or work. Completely waterproof thanks to the water repellent fabric and zips. External fabric made with recycled plastic. Equipped with numerous compartments, anti-theft pocket and reflective inserts. Laptop compartment (up to 13") 28x26cm. Tablet compartment: 30x22cm. Capacity: 12L. Dimensions: 28x39x13cm. Available in 3 color variants: black, black and beige, black and blue.

FR Sac à dos City Life Compact idéal pour la vie HI-TECH. Conçu pour tous ceux qui passent la plupart de leur temps hors de chez eux à étudier ou à travailler. Totalement imperméable grâce au tissu et aux fermetures à glissière hydrofuges. Tissu extérieur fabriqué en plastique recyclé. Équipé de nombreux compartiments, d'une pochette antivols et d'inserts réfléchissants. Compartiment pour ordinateur portable: 28x26cm. Compartiment pour tablette: 30x22cm. Contenance 12L. Dimension: 28x39x13cm. Disponible en 3 variantes de couleurs: noir, noir et beige, noir et bleu.





WD580 CITY LIFE

IT Zaino City Life ideale per la vita urbana e Hi-tech.

Ideato per tutti coloro che trascorrono la maggior parte del tempo fuori casa per studio o per lavoro. Completamente impermeabile grazie al tessuto e alle zip idrorepellenti. Tessuto esterno realizzato con plastica riciclata. Dotato di numerosi scomparti, tasca antifurto e inserti riflettenti. Scomparto Laptop: 38x24cm Scomparto Tablet: 30x22cm. Litraggio: 19L. Disponibile in 4 varianti di colore: nero, nero e giallo, nero e grigio, nero e rosso.

EN Backpack City Life, ideal for urban and Hi-tech life. Designed for all those who spend most of their time away from home for study or work. Completely waterproof thanks to the water repellent fabric and zips. External fabric made with recycled plastic. Equipped with numerous compartments, anti-theft pocket and reflective inserts. Laptop compartment: 38x24cm Tablet compartment: 30x22cm Capacity: 19L. Available in 4 color variants: black, black and yellow, black and gray, black and red.

FR Sac à dos CITY LIFE idéal pour la vie HI-TECH. Conçu pour tous ceux qui passent la plupart de leur temps hors de chez eux à étudier ou à travailler. Totalement imperméable grâce au tissu et aux fermetures à glissière hydrofuges. Tissu extérieur fabriqué en plastique recyclé. Équipé de nombreux compartiments, d'une pochette antivol et d'inserts réfléchissants. Compartiment pour ordinateur portable: 38x24cm Compartiment pour tablette: 30x22cm. Contenance 19L. Disponible en 4 variantes de couleurs: noir, noir et jaune noir et gris, noir et rouge.

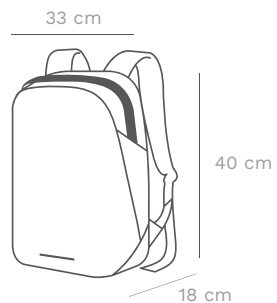

Scomparto per laptop e tablet
Compartiment pour ordinateur portable et tablette
Laptop & tablet
Compartment



Custodia per bottiglietta
Porte-bouteilles
Bottle case

Custodia imbottita
Étui rembourré
Padded case

Custodia Lunch Box
Étui pour lunch box
Lunch box case



Custodia Lunch Box
Étui pour lunch box
Lunch box case

Espandibile
Extensible
Expandable

Non lavare
Don't wash
Ne pas laver

Non stirare
Don't iron
Ne pas repasser





Portachiavi
Porte-clés rétractable
Retractable key holder



Plastique recyclé
Recycled plastic



Impermeabile
Waterproof
Étanche



Zip invisible
Hidden zip
Fermeture éclair cachée



Tasca antifurto
Anti-theft pocket
Pochette anti-vol



Tasca antifurto
Anti-theft pocket
Pochette anti-vol



Entrata e uscita USB
Entrée et sortie USB
USB input & output



Uscita per cuffie
Hearphone output
Sortie pour écouteurs

NAPA LINE



WD018FOG



WD018VIN



WD018DAG



WD018DAB

WD018

IT Glacette morbida raffreddabottiglie decorata.

Per un corretto utilizzo riporre in freezer per alcune ore, una volta tolta infila la bottiglia al suo interno per avere un vino sempre fresco durante il pasto. Dimensioni: 15,5x22,5x2cm.

EN Soft decored glacette bottle cooler. For a correct use, place in the freezer for a few hours, once removed put the bottle inside to keep your wine cool during the meal. Dimensions: 15,5x22,5x2cm.

FR Rafraîchisseur de bouteille décoré pour refroidir les bouteilles. Pour une bonne utilisation, mettre au congélateur pendant quelques heures, une fois retiré, glisse la bouteille à l'intérieur pour avoir un vin toujours frais pendant le repas. Dimensions: 15,5x22,5x2cm.



WD018KAS



WD018PET



WD018DAM



WD018MAIO



WD018BEI



WD018BOR



WD018BLU



WD018GOLD



WD018RED



WD018B



WD018SILVER



WD018BLACK

WD018

IT Glacette morbida raffreddabottiglie monocolori.

Per un corretto utilizzo riporre in freezer per alcune ore, una volta tolta infila la bottiglia al suo interno per avere un vino sempre fresco durante il pasto. Dimensioni: 15,5x22,5x2cm.

EN Soft monochrome glacette bottle cooler. For a correct use, place in the freezer for a few hours, once removed put the bottle inside to keep your wine cool during the meal. Dimensions: 15,5x22,5x2cm.

FR Rafraîchisseur de bouteille unicolore. Pour une utilisation correcte, placez la bouteille dans le congélateur pendant quelques heures, une fois retirée, placez la bouteille à l'intérieur pour avoir un vin toujours frais pendant le repas. Dimensions: 15,5x22,5x2cm.



WD440T

IT Glacette a doppia parete (interno acciaio ed esterno plastica) per bottiglie 0,75L. e spumanti. Ideale per mantenere in temperatura di degustazione i tuoi vini, spumanti e altre bevande. Misura: Ø 11,5x20cm.

EN Double wall ice bucket (stainless steel and plastic) for bottles of 0,75L. and champagne. Keeps your wine and drinks at correct serving temperature. Size: Ø 11,5x20cm.

FR Rafraîchisseur de bouteille à double paroi (intérieur acier et extérieur plastique) pour bouteilles de 750ml et vins mousseux. Idéal pour conserver vos vins, vins mousseux et autres boissons à la température de dégustation. Taille: Ø 11,5x20cm.



Si lavastoviglie
Dishwasher safe
Lave-vaisselle possible



No microonde
Nomicrowave
Pas de micro-ondes

ROMA LINE



IT Ruota il taglia capsule attorno alla capsula per una o due volte per tagliare il sigillo.

EN Rotate the foil cutter around the foil seal for one to two circles to cut the foil seal.

FR Tournez-le coupe-capsules autour de la capsula pour un ou deux fois pour couper le joint.



IT Posiziona il cavatappi sopra la bottiglia e premi il pulsante inferiore affinché il tappo venga estratto.

EN Place the corkscrew over the bottle and press the lower button to make the cork pop out.

FR Placez le tire-bouchon sur la bouteille et appuyez sur le bouton inférieur pour faire extraire le bouchon deux fois pour couper le joint.



IT Premi il pulsante superiore per qualche secondo; il tappo uscirà automaticamente dal cavatappi.

EN Press the top button for a few seconds; the cork will automatically come out of the corkscrew.

FR Appuyez sur le bouton du haut pendant quelques secondes; le bouchon sortira automatiquement du tire-bouchon.

WD637

IT Cavatappi elettrico in finitura nero opaco.

Rimuove facilmente il tappo in pochi secondi ed è adatto alla maggior parte delle dimensioni standard di bottiglie. Tagliacapsule incluso nella confezione.

EN Electric wine bottle opener in matt black finish. It easily removes the cork in a few seconds and fits most standard wine bottle sizes. Foil cutter included in the package.

FR Tire-bouchon électrique en finition noir mat. Il extrait facilement le bouchon en quelques secondes et s'adapte à la plupart des tailles de bouteilles de vin standard. Coupe-capsules inclus dans l'emballage.

AA
include
integrated
intégrée

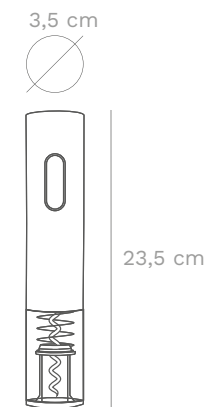



*Non altera il sapore
It does not alter the flavor
Ne modifie pas le goût*

*Riutilizzabile
Reusable
Réutilisable*

2,7 cm



2,7 cm



Drink sempre freddo
Always cool drink
Boissons toujours froides



Non annacqua
No watery drink
Ne se dilue pas



Si lavastoviglie
Dishwasher safe
Lave-vaisselle possible



No microonde
Nomicrowave
Pas de micro-ondes

4 cm

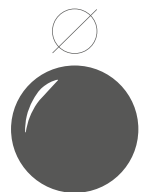

WD588

IT Set di 6 cubetti in acciaio inox riutilizzabili con pratico sacchetto in velluto nero.

Questi cubetti manterranno il tuo cocktail sempre fresco e non annacquato. Per un corretto utilizzo riponi i cubetti in freezer per min 2 ore, una volta raffreddati utilizzali nei tuoi cocktail. Lavabili in lavastoviglie.

EN Set of 6 reusable stainless steel cubes with practical black velvet pouch. These cubes will keep your cocktail always cool and not watered down. For a correct use, place the product in the freezer for at least 2 hours, once cooled use them in your cocktails. Dishwasher safe.

FR Set de 6 glaçons CUBE en acier inoxydable avec pochette pratique en velours noir. Ces cubes permettront à votre cocktail d'être toujours frais et non dilué. Pour une bonne utilisation, placez les cubes au congélateur pendant au moins 2 heures. Une fois refroidis, utilisez-les dans vos cocktails. Lavable au lave-vaisselle. Après utilisation, rincez, séchez et rangez dans le sac.



WD587

IT Set di 4 sfere in acciaio inox riutilizzabili con pratico sacchetto in velluto nero.

Queste sfere manterranno il tuo cocktail sempre fresco e non annacquato. Per un corretto utilizzo riponi le sfere in freezer per min 2 ore, una volta raffreddate utilizzale nei tuoi cocktail. Lavabili in lavastoviglie.

EN Set of 4 reusable stainless steel spheres with practical black velvet bag. These spheres will keep your cocktail always cool and not watered down. For correct use, place the spheres in the freezer for at least 2 hours, once cooled use them in your cocktails.

FR Set de 4 glaçons SPHERE en acier inoxydable avec pochette pratique en velours noir. Ces sphères permettront à vos cocktails de rester toujours frais et non dilués. Pour une bonne utilisation, placez les boules au congélateur pendant au moins 2 heures. Une fois refroidies, utilisez-les dans vos cocktails. Lavable au lave-vaisselle. Après utilisation, rincez, séchez et rangez dans le sac.





*Beccuccio antigoccia
Anti drip spout
Bec verseur anti-goutte*

*Non altera il sapore
It does not alter the flavor
Ne modifie pas le goût*

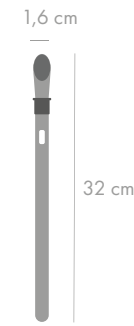
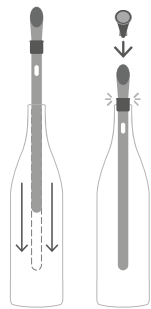

WD589

IT Stick raffreddavino in acciaio inox con tappo ermetico.

Questo prodotto manterrà il tuo vino a temperatura per tutto il pasto. Per un corretto utilizzo riporre in freezer per circa 4 ore, inserire attraverso il collo della bottiglia. Lavabile in lavastoviglie.

EN Stainless steel wine chiller stick with hermetic cap. This product will keep your wine at temperature throughout the meal. For a correct use, place it in the freezer for about 4 hours, then insert it through the neck of the bottle. Dishwasher safe. After use, rinse it and dry it.

FR Bec verseur de vin 3 en 1 Ce bec verseur de vin remplit 3 fonctions: verseur anti-goutte, bouchon hermétique et rafraichisseur. Pour rafraichir vos boissons, placez le bec verseur 3 en 1 au congélateur, pendant environ 4 heures. Le bec-verseur s'adapte à tout type de bouteilles. Lavable au lave-vaisselle.



Si lavastoviglie
Dishwasher safe
Lave-vaisselle possible



No microonde
Nomicrowave
Pas de micro-ondes



Drink sempre freddo
Always cool drink
Boissons toujours froides



Non annacqua
No watery drink
Ne se dilue pas





WD607

IT Set cocktail professionale in acciaio inox, in astuccio tela con cinghia in ecopelle e maniglia per trasportarlo facilmente. Composto da 6 pezzi. Capacità Shaker: 700ml, Capacità Jigger: 35ml.

EN Professional cocktail set in stainless steel, in a canvas case with PU leather belt and handle to carry it easily. Composed by 6 pieces. Shaker's capacity: 700ml, Jigger Capacity: 35ml.

FR Service à cocktail professionnel en acier inoxydable, dans un étui en toile avec une sangle et une poignée en faux cuir pour un transport facile. Composé de 6 pièces. Contenance du shaker: 700ml, Contenance du jigger: 35ml.



Facile trasporto
Easy carry
Facile à transporter



Si lavastoviglie
Dishwasher safe
Lave-vaisselle possible



No microonde
Nomicrowave
Pas de micro-ondes



No lavastoviglie
No dishwasher
Pas de lave-vaisselle



No microonde
Nomicrowave
Pas de micro-ondes

WD579

IT Sciabola da Sommelier con manico in legno e corda in raso. Dimensioni: 46,5cm.

EN Sommelier saber with wooden handle and satin cord. Dimensions: 46,5cm.

FR Sabre de sommelier avec manche en bois et cordon en satin. Dimensions: 46,5cm.





WD424

IT Set cocktail in acciaio INOX con finitura rosegold composto da: shaker (800ml), colino, misurino dosatore doppio, cucchiaio dosatore. Capacità Jigger: 35ml.

EN Stainless steel cocktail set with rosegold finishing composed ofW: shaker (800ml), jigger, strainer, spoon. Jigger Capacity: 35ml.

FR Service à cocktail en acier inoxydable avec finition rose comprenant: un shaker (800ml), un strainer, une double tasse à mesurer, une cuillère à mesurer. Contenance du jigger: 35ml.

 Si lavastoviglie
Dishwasher safe
Lave-vaisselle possible

 No microonde
Nomicrowave
Pas de micro-ondes





WD572

IT Set composto da Boston shaker e strainer.

Questo shaker professionale è completo di bicchiere in acciaio INOX e bicchiere in vetro. Perfetto per realizzare cocktails deliziosi ed elaborati. Capacità: 800ml.

Dimensioni bicchiere in acciaio INOX: h 17cm Ø 9,3cm ø 6cm.
Dimensioni bicchiere in vetro: h 14,8cm Ø 8,8cm ø 6cm.
Dimensioni strainer: h 14,6cm x l 9,2cm.

EN Set consisting of Boston shaker and strainer. This professional shaker is composed of a stainless steel container and a glass. Perfect for making delicious and elaborate cocktails. Capacity: 800ml.

Stainless steel glass dimensions: h 17cm Ø 9.3cm ø 6cm.
Glass dimensions: h 14.8cm Ø 8.8cm ø 6cm.
Strainer dimensions: h 14.6cm x l 9.2cm.

FR Ensemble composé d'un Boston shaker et d'un strainer. Ce shaker professionnel est complet avec un gobelet en acier inoxydable et d'un verre. Parfait pour réaliser des cocktails délicieux et élaborés. Contenance: 800ml.

Dimensions du gobelet en acier inoxydable: h 17cm Ø 9,3cm ø 6cm.
Dimensions du verre: h 14,8cm Ø 8,8cm ø 6cm.
Dimensions du strainer: h 14,6cm x l 9,2cm.

 Si lavastoviglie
Dishwasher safe
Lave-vaisselle possible

 No microonde
Nomicrowave
Pas de micro-ondes

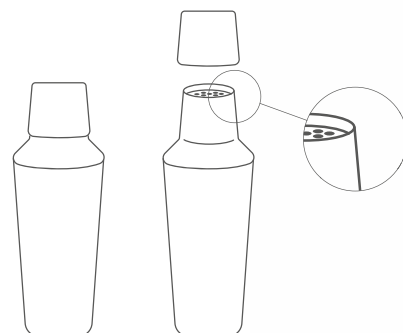

WD573

IT Cocktail shaker professionale da 800ml in acciaio INOX, con filtro integrato

Prepara dei cocktail professionali per le occasioni speciali a casa tua. Dimensioni: h 22,9cm Ø 8,7cm ø 6,5cm.

EN 800ml professional cocktail shaker in stainless steel, with integrated filter. Prepare professional cocktails for your special occasions at home. Dimensions: h 22,9cm Ø 8,7cm ø 6,5cm.

FR Shaker à cocktail professionnel de 800ml en acier inoxydable avec filtre intégré. Préparez chez vous des cocktails professionnels pour les grandes occasions. Dimensions: h 22,9cm Ø 8,7cm ø 6,5cm.

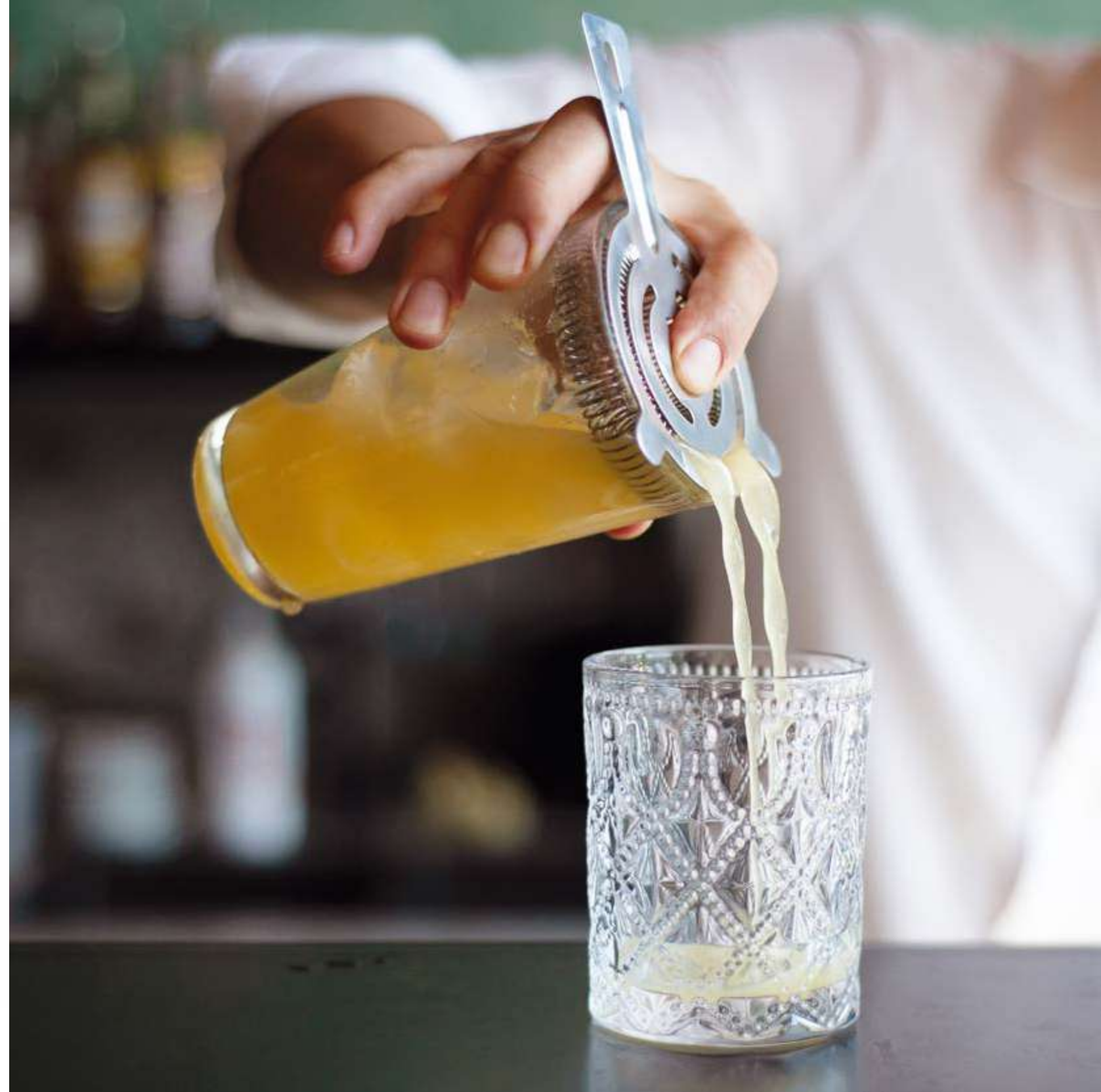



WD480

IT Moscow Mule Mug in acciaio placcato rame con effetto martellato. Capacità 500ml.

EN Moscow Mule Mug. Copper plated stainless steel mug with hammered finishing. Capacity 500ml.

FR Moscow Mule Mug en acier plaqué cuivre avec effet martelé. Contenance: 500ml.

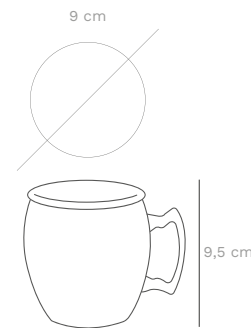

Si lavastoviglie
Dishwasher safe
Lave-vaisselle possible



No microonde
Nomicrowave
Pas de micro-ondes

WD523

IT Set 6 cannucce in acciaio INOX riutilizzabili con scovolino.

EN Set 6 stainless steel reusable straws and cleaning brush.

FR Ensemble de 6 pailles réutilisables en acier inoxydable avec cure-pipe.



0,8 cm
∅

21 cm



WD523S

WD523N

WD523R



Legno FSC
FSC wood
Bois FSC

WD591

IT Tagliere in legno di acacia FSC®, con ricetta cocktail incisa. Manico con foro e cordino per aggancio. Dimensioni: 29,5x15cm.

EN FSC® acacia wood cutting board, with engraved cocktail recipe. Handle with hole and cord for hooking. Dimensions: 29.5x15cm.

FR Planche à découper en bois d'acacia FSC®, avec recette de cocktail gravée. Poignée avec trou et cordon d'attache. Dimensions: 29,5x15cm.



WD593

IT Tagliere in legno di acacia FSC®, con ricetta cocktail incisa. Manico con foro e cordino per aggancio. Dimensioni: 40,8x17cm.

EN FSC® acacia wood cutting board, with engraved cocktail recipe. Handle with hole and cord for hooking. Dimensions: 40.8x17cm.

FR Planche à découper en bois d'acacia FSC®, avec recette de cocktail gravée. Poignée avec trou et cordon d'attache. Dimensions: 40,8x17cm.



No lavastoviglie
No dishwasher
Pas de lave-vaisselle



No microonde
Nomicrowave
Pas de micro-ondes

LEGNO DI ACACIA DALL'ISOLA DI HAINAN

Il legno di acacia di questo tagliere proviene dall'isola di Hainan. Un'isola del sud della Cina, di origine vulcanica, presenta spiagge basse contraddistinte da una sabbia finissima di color bianco, e una lussureggiante vegetazione di tipo subtropicale intatta. L'isola ospita una vasta area di coltivazioni di Acacia Mangium. Questo albero cresce molto velocemente e può arrivare fino a 20 m.

La certificazione FSC® attesta la provenienza DEL LEGNO da foreste che rispettano rigorosi standard ambientali, sociali ed economici.

ACACIA WOOD FROM THE HAINAN ISLAND

The acacia wood of this cutting board comes from the Hainan island. An island in southern China, of volcanic origin, characterized by low beaches with very fine white sand, and by a lush, intact subtropical vegetation. The island is home to a large area of Acacia Mangium cultivation. This tree grows very fast and can reach up to 20 m height.

The FSC® certification certifies the origin OF WOOD from forests that respect rigorous environmental, social and economic standards.

BOIS D'ACACIA DE L'ÎLE DE HAINAN

Le bois d'acacia utilisé pour cette planche à découper provient de l'île de Hainan. Cette île volcanique du sud de la Chine possède des plages peu profondes de sable blanc et fin et une végétation subtropicale luxuriante et préservée. L'île abrite une grande zone de culture d'Acacia Mangium. Cet arbre pousse très vite et peut atteindre jusqu'à 20 m de haut.

La certification FSC® atteste que le bois provient de forêts qui respectent des normes environnementales, sociales et économiques strictes.



WD592

IT Tagliere in legno di acacia FSC®, con ricetta cocktail incisa. Manico con foro e cordino per aggancio. Dimensioni: 31,6x24,6cm.

EN FSC® acacia wood cutting board, with engraved cocktail recipe. Handle with hole and cord for hooking. Dimensions: 31.6x24.6cm.

FR Planche à découper en bois d'acacia FSC®, avec recette de cocktail gravée. Poignée avec trou et cordon d'attache. Dimensions: 31,6x24,6cm.



WD594

IT Tagliere in legno di acacia FSC®, con ricetta cocktail incisa. Manico con foro e cordino per aggancio. Dimensioni: 50x13cm.

EN FSC® acacia wood cutting board, with engraved cocktail recipe. Handle with hole and cord for hooking. Dimensions: 50x13cm.

FR Planche à découper en bois d'acacia FSC®, avec recette de cocktail gravée. Poignée avec trou et cordon d'attache. Dimensions: 50x13cm.

DUBAI LINE



WD477A



WD477B



WD477TR

WD477

IT Set 4 bicchieri acqua in vetro con decoro a rilievo in 3 varianti di colori. Ideali per donare alla vostra tavola un tocco di eleganza ed originalità! Capacità: 300ml

EN Set of 4 colored glasses with relief decorations, available in 3 colors. Ideal glasses to give to your table a touch of elegance and originality! Capacity: 300ml.

FR Set de 4 verres avec décoration relief soit en transparent, soit 3 couleurs. Matière: verre. Idéal pour donner à votre table une touche d'élégance et d'originalité! Contenance: 300ml.



Si lavastoviglie
Dishwasher safe
Lave-vaisselle possible



Si microonde
Microwave safe
Micro-ondes possible



WD475

IT Set 4 calici in vetro con decoro a rilievo in 3 varianti di colori. Ideali per donare alla vostra tavola un tocco di eleganza ed originalità! Capacità: 400ml.

EN Set of 4 colored goblets with relief decorations, available in 3 colors. Ideal glasses to give to your table a touch of elegance and originality! Capacity: 400ml.

FR Set de 4 verres à pied avec décoration relief soit en transparent, soit 3 couleurs. Matière: Verre. Idéal pour donner à votre table une touche d'élégance et d'originalité! Contenance: 400ml.



Si lavastoviglie
Dishwasher safe
Lave-vaisselle possible



Si microonde
Microwave safe
Micro-ondes possible



WD475A



WD475B



WD475TR

WD478

IT Brocca in vetro con decoro a rilievo in 3 varianti di colori. Ideale per donare alla vostra tavola un tocco di eleganza ed originalità! Capacità: 1,5L.

EN Colored glass pitcher with relief decorations, available in 3 colors. Ideal glasses to give to your table a touch of elegance and originality! Capacity: 1,5L.

FR Pichet avec décoration relief soit en transparent, soit 3 couleurs. Matière: Verre. Idéal pour donner à votre table une touche d'élégance et d'originalité! Contenance: 1,5L.



WD478A



WD478B



WD478TR



WD684

IT Set 4 coppette in vetro con decoro a rilievo. Adatte per le occasioni speciali ma anche per l'uso quotidiano, perfette per servire deliziosi gelati e sfiziosi dessert. Capacità: 400 ml. Dimensione: Ø 12,7 cm H 6,6 cm. Disponibile in 3 varianti di colore: trasparente, blu, ambr.

EN Set of 4 glass cups with relief decoration. Suitable for special occasions but also for everyday use, perfect for serving delicious ice creams and tasty desserts. Capacity: 400 ml. Size: Ø 12.7 cm H 6.6 cm. Available in 3 colours: transparent, blue, amber.

FR Set de 4 tasses en verre avec décoration en relief. Convient pour les grandes occasions mais aussi pour un usage quotidien, parfait pour servir de délicieuses glaces et de savoureux desserts. Contenance: 400 ml. Taille: Ø 12,7 cm H 6,6 cm. Disponible en 3 couleurs: transparent, bleu, ambre.



COLORI

No lavastoviglie
No dishwasher
Pas de lave-vaisselle

No microonde
Nomicrowave
Pas de micro-ondes

TRASPARENTE

Si lavastoviglie
Dishwasher safe
Lave-vaisselle possible

Si microonde
Microwave safe
Micro-ondes possible

WD685

IT Set 4 flûte in vetro con decoro in rilievo. Donano eleganza e raffinatezza durante i tuoi brindisi più importanti, perfetti per accompagnarti nei festeggiamenti con amici e familiari. Capacità: 150 ml. Dimensione: Ø 5,8 cm H 19,5 cm. Disponibile in 3 varianti di colore: trasparente, blu, ambr.

EN Set of 4 glass flûtes with relief decoration. They bring elegance and sophistication to your most important toasts, perfect for accompanying you in celebrations with friends and family. Capacity: 150 ml. Size: Ø 5.8 cm H 19.5 cm. Available in 3 colour variants: transparent, blue, amber.

FR Set de 4 flûtes en verre avec décoration en relief. Elles apportent élégance et sophistication à vos toasts les plus importants, parfaites pour vous accompagner dans les célébrations avec vos amis et votre famille. Contenance: 150 ml. Taille: Ø 5,8 cm H 19,5 cm. Disponible en 3 variantes de couleurs: transparent, bleu, ambre.

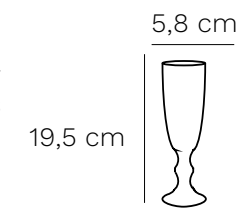

SIENA LINE



Acqua



Bevimi



Fresca



Frizzante



Mezzo pieno



Naturale



WD586

IT Set 6 bicchieri in vetro borosilicato decorati con 6 diversi aforismi.

Grazie alle proprietà del vetro borosilicato questi bicchieri sono molto resistenti e allo stesso tempo particolarmente trasparenti e leggeri. Capacità: 300ml.

EN Set composed by 6 borosilicofed glasses decorated with 6 different quotes. Thanks to the properties of borosilicate glass, these glasses are very resistant and at the same time particularly transparent and light. Capacity: 300ml.

FR Ensemble de 6 verres à eau en verre borosilicate décorés de 6 aphorismes différents. Grâce à la propriété du verre borosilicate, ces verres sont très durables et en même temps particulièrement transparents et légers. Capacité: 300ml.



Si lavastoviglie
Dishwasher safe
Lave-vaisselle possible



Si microonde
Microwave safe
Micro-ondes possible

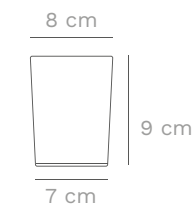



WD577B

Boy Scout



WD577C

Classica



WD577F

Fiaschetta



WD577T

Tanica

WD577

IT Oliera/Acetierra in vetro borosilicato.

Con beccuccio anti-goccia per dosare correttamente l'olio o l'aceto nelle tue pietanze. La sabbiatura sul collo permette una chiusura ermetica e una perfetta tenuta evitando gocciolamenti. Grazie alle proprietà del vetro borosilicato è molto resistente ed allo stesso tempo particolarmente trasparente e leggera.

EN With anti-drip spout to correctly dose the oil or vinegar in your dishes. The sandblasting on the neck allows a hermetic closure and a perfect seal avoiding any dripping. Thanks to the properties of borosilicate glass, this oil / vinegar bottle is very resistant and at the same time particularly transparent and light.

FR Huilier/Vinaigrier en verre borosilicate. Avec bec verseur anti-goutte pour doser correctement l'huile ou le vinaigre dans vos plats. Le sablage du col permet une fermeture hermétique et une étanchéité parfaite évitant les coulures. Les propriétés du verre borosilicate permettent d'avoir des produits légers, transparents et très résistants.



Becco antigoccia
Anti-drip spout
Bec anti-goutte



Si lavastoviglie
Dishwasher safe
Lave-vaisselle possible



Si microonde
Microwave safe
Micro-ondes possible

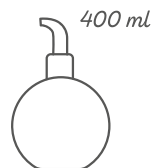

400 ml

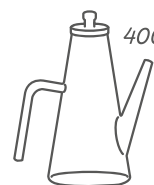

400 ml



300 ml



350 ml



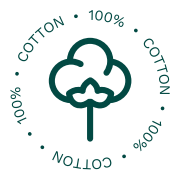

WD571DECV



WD571DECR

WD571

IT Sacchetto per pane in 100% cotone.

Con cuscino contenente semi di ciliegio per preservare il calore del pane appena sfornato o per servirlo in tavola caldo. Per un corretto utilizzo riscaldare il cuscino in microonde per massimo 2 minuti a potenza media, chiudere la zip per ottenere un calore più duraturo. Non riscaldare nel forno. Non scaldare il sacchetto nel microonde. Dimensioni: 20x30cm.

EN Bread bag in 100% cotton. With pillow containing cherry seeds to preserve the warmth of freshly baked bread or to serve it hot. For a correct use, heat the pillow in the microwave for maximum 2 minutes at medium power, close the zip to obtain a longer lasting heat. Do not heat in the oven. Do not heat the bag in the microwave. Dimensions: 20x30cm.

FR Caractéristiques: sac à pain 100% coton. Avec coussin contenant des graines de cerisier pour préserver la chaleur du pain fraîchement cuit ou pour le servir chaud à table. Pour une utilisation correcte, chauffez le coussin au micro-ondes pendant 2 minutes maximum à puissance moyenne, fermez le zip pour obtenir une chaleur plus durable. Dimensions: 20x30cm.



Lavare a mano
Hand wash
Lavage des mains



IT Estrarre il cuscino con i semi di ciliegio.
EN Take out the pillow with the seeds.
FR Extraire le coussin en noyaux de cerises.



IT Riscaldare in microonde per max 2 min.
EN Heat in the microwave for max 2 min.
FR Le réchauffer au micro-ondes pendant 2 minutes max.



IT Riporre il cuscino all'interno del sacchetto.
EN Place the pillow inside the bag.
FR placez le coussin à l'intérieur du sac.



IT Inserire il pane per mantenerlo caldo.
EN Insert the bread to keep it warm.
FR Déposer le pain dans la corbeille.



WD571BE



WD571G



WD571R



WD571V



Lavare a mano
Hand wash
Lavage des mains

Sacchetto in 100% cotone.
Bag in 100% cotton.
Sac 100% coton.

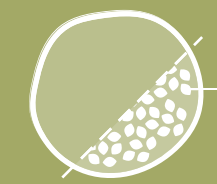
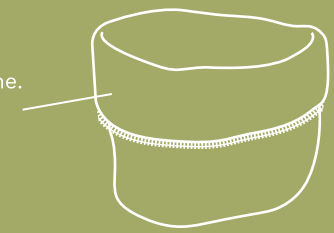

Cuscino in 100% cotone riempito
con semi di ciliegio.
Pillow in 100% cotton filled with
cherry seeds.
Cussion en 100% coton, rempli
de noyaux de cerises.

PECHINO LINE



Si lavastoviglie
Dishwasher safe
Lave-vaisselle possible

Si microonde
Microwave safe
Micro-ondes possible

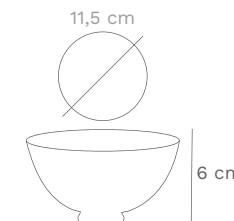

WD698

IT Set 6 coppette decorate.

Esterno decorato con texture ed interno monocolore. Perfette per servire il dessert donando uno stile orientale alla tua tavola. Materiale: ceramica. Capacità: 300ml. Misure: Ø 11,5cm, h 6cm.

EN Set of 6 decorated cups. External part with print design, internal part in solid colour. Recommended to serve the dessert giving an oriental style to your table. Material: ceramic. Capacity: 300ml. Size: ø 11,5cm, h 6cm.

FR Set de 6 bols décorés. Extérieur texturé et intérieur unicolore. Parfait pour servir un dessert en donnant un style oriental à votre table. Matière: céramique. Contenance: 300ml. Dimensions: ø 11,5cm, h 6cm.



WD699

IT Set 3 vassoi rettangolari in 3 misure e 3 decorazioni differenti.

Pratico e colorato set di vassoi per servire thé, aperitivi e caffè donando un tocco orientale alla vostra tavola. Grazie ai ricercati decori questo articolo diventa un elemento decorativo per la tua casa. Materiale: ceramica. Misure: 30x15,5cm, 23,5x11,5cm, 11x6cm.

EN Set of 3 rectangular tray in 3 sizes and 3 different decorations. Practical and colourful set of trays for serving tea, aperitifs and coffee giving an oriental touch to your table. Thanks to the refined decorations this article is also a decorative element for your house. Size: 30x15,5cm, 23,5x11,5cm, 11x6cm.

FR Set de 3 plateaux rectangulaires en 3 tailles et 3 décorations différents. Set de plateaux pratiques et colorés pour servir le thé, les apéritifs et le café en donnant une touche orientale à votre table. Grâce aux décorations raffinées, cet article devient un élément décoratif pour votre maison. Matière: céramique. Tailles: 30x15,5 cm, 23,5x11,5 cm, 11x6 cm.

Si lavastoviglie
Dishwasher safe
Lave-vaisselle possible

Si microonde
Microwave safe
Micro-ondes possible

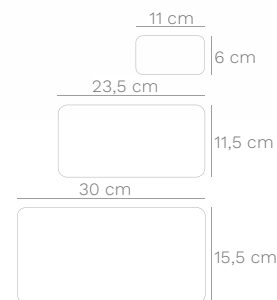



WD700A

WD700B

WD700

IT Set 2 coppette decorate a rilievo, 2 bacchette e 2 poggia bacchette.

Questo set in perfetto stile asiatico, ti consente di dare originalità e colore ai tuoi piatti orientali. Materiale: ceramica. Capacità: 300ml. Misure: Ø 11,5cm h 6cm, 5x1cm.

EN Set of 2 cups decorated in relief, 2 chopsticks and 2 chopstick rests. This set in perfect Asian style allows you to add originality and color to your oriental dishes. Material: ceramic. Capacity: 300ml. Size: Ø 11,5cm h 6cm, 5x1cm.

FR Set de 2 bols décoration en relief, 2 baguettes et 2 porte-baguettes. Ce set au style asiatique vous permet d'ajouter de originalité et de la couleur à vos plats orientaux. Matière: céramique. Contenance: 300ml. Dimensions: Ø 11,5cm h 6cm, 5x1cm.

 Si lavastoviglie
Dishwasher safe
Lave-vaisselle possible

 Si microonde
Microwave safe
Micro-ondes possible

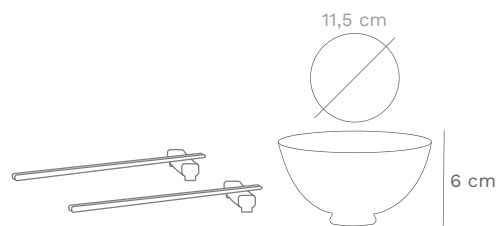

 Si lavastoviglie
Dishwasher safe
Lave-vaisselle possible

 Si microonde
Microwave safe
Micro-ondes possible

WD701B



WD701A

WD701

IT Kit 2 piattini e 2 ciotoline decorate a rilievo, 2 bacchette e 2 poggia bacchette.

Questo kit in perfetto stile asiatico, ti consente di portare originalità e autenticità ai tuoi piatti orientali. Materiale: ceramica. Misure: piattini 13x13cm; ciotoline 8x5,7cm; poggia bacchette 5x1cm.

EN Kit consisting of 2 plates and 2 saucers with embossed decorations, 2 chopsticks and 2 chopstick holders. This kit in perfect Asian style allows you to serve your oriental dishes with originality and authenticity. Material: ceramic. Size: saucers 13x13cm; small bowls 8x5,7cm; chopstick rest 5x1cm.

FR Set de 2 petites assiettes carrées et 2 petites coupelles avec décoration relief. Fournie avec 2 baguettes et 2 porte-baguettes. Ce kit au style asiatique vous permet d'apporter originalité et authenticité à vos plats orientaux. Matière: céramique. Dimensions: soucoupes 13x13cm; petits bols 8x5,7cm; repose-baguettes 5x1cm.

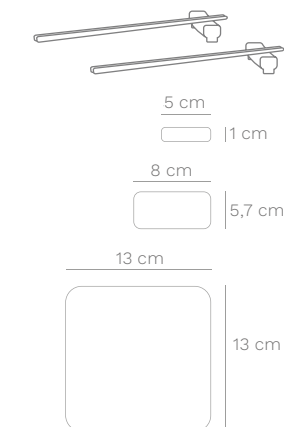



WD702

IT Set 2 ciotole Ramen con decorazione a rilievo corredato da 2 coppie di bacchette.

Questo set è perfetto per dare un tocco di originalità alle tue combinazioni Poke, Ramen e Noodles. Materiale: ceramica. Capacità: 800ml. Dimensioni: 14x11cm.

EN Set composed of 2 bowls with embossed decorations and 2 chopstick pairs. Ideal for ramen, poke and noodles. This set is perfect to give originality to your oriental dishes. Material: ceramic. Capacity: 800ml. Size: 14x11cm.

FR Ensemble de 2 bols à Ramen avec décoration en relief accompagnés de 2 paires de baguettes. Ce set est parfait pour ajouter une touche d'originalité à vos combinaisons de Poke, Ramen et Noodles. Matière: céramique. Contenance: 800ml. Dimensions: 14x11cm.

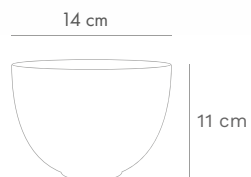

WD703

IT Tazza in ceramica con decorazione.

Perfetta per dare un tocco di originalità al tuo momento del tè., scegli le combinazioni che più preferisci per donare colore alla tua tavola. Materiale: ceramica. Capacità: 360ml. Misura: Ø 9cm x h 11cm.

EN Ceramic mug with decoration. Perfect to give a touch of originality to your tea time. Choose your favourite combinations to add colour to your table. Material: ceramic. Capacity: 360ml. Size: Ø 9cm x h 11cm.

FR Tasse en céramique avec décoration. Parfait pour donner une touche d'originalité à votre heure du thé. Choisissez vos combinaisons préférées pour ajouter de la couleur à votre table. Matière: céramique. Contenance: 360 ml. Dimensions: Ø 9cm x h 11cm.



WD703A



WD703B



WD703C



WD703D



WD704A



Togliere il manico prima di inserire in lavastoviglie
Remove the handle before placing in the dishwasher
Retirer la poignée avant de mettre au lave-vaisselle

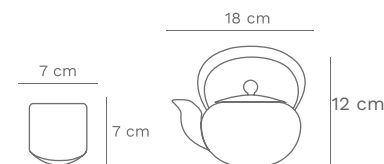

WD704B



WD704

IT Set teiera con manico in bamboo e 4 tazze decorate a rilievo.

Questo set in perfetto stile asiatico, ti consentirà di dare originalità e autenticità ai tuoi momenti di relax. Materiale: ceramica. Capacità teiera: 750ml. Capacità tazze: 160ml. Misure: teiera 18x12cm, tazze 7x7cm.

EN Teapot set with bamboo handle and 4 relief decorated cups. This set in perfect Asian style will allow you to give originality and authenticity to your moments of relaxation. Material: ceramic. Teapot capacity: 750ml. Cup capacity: 160ml. Size: teapot 18x12cm, cups 7x7cm.

FR Ensemble théière avec 4 gobelets avec décoration relief. Théière avec poignée bamboo et filtre. Cet ensemble au style asiatique vous permettra de donner originalité et authenticité à vos moments de détente. Matière: céramique. Capacité de la théière: 750ml. Capacité de la tasse: 160ml. Dimensions: théière 18x12cm, tasses 7x7 cm.



WD705

IT Set 4 piatti da dessert.

Questo set in perfetto stile asiatico ti consente di servire i tuoi dessert donando originalità e colore alla tua tavola. Materiale: ceramica. Dimensioni: Ø 20 cm.

EN Set of 4 dessert plates. This Asian-style set allows you to serve your desserts while bringing originality and colour to your table. Material: ceramic. Dimensions: Ø 20 cm.

FR Set de 4 assiettes à dessert. Ce set au style asiatique vous permet de servir vos desserts tout en apportant originalité et couleur à votre table. Matière: céramique. Dimensions: Ø 20 cm.

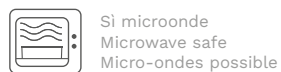

20 cm

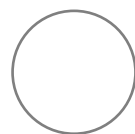

WD707

IT Kit 2 set bacchette in legno con decoro e 2 poggia bacchette.

Un kit colorato ed originale, perfetto come regalo ad amici e parenti ma anche per decorare ed abbellire la tua tavola.

EN Set of 2 wooden chopsticks with decoration and 2 chopstick rests. A colourful and original kit, perfect as a gift to friends and family but also to decorate and embellish your table.

FR Set de 2 baguettes en bois avec décoration et 2 porte-baguettes. Un kit coloré et original, idéal pour offrir aux amis et à la famille, mais aussi pour décorer et embellir la table.



WD707A



WD707B



WD707C



WD707D

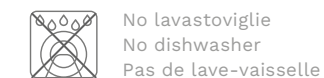



WD609

IT Set 6 coppette.

Con interno decorato lucido ed esterno monocolor matt. 6 decori e 6 colori diversi. Abbinabili alle tovagliette WD608. Materiale: ceramica. Capacità: 300ml. Misure: Ø 11,5cm, h 6cm.

EN Set of 6 bowls, glossy decorated interior and matt one-color exterior. With 6 different colors and decorations. Discover the different possible combinations with WD lifestyle placemats. Material: ceramic. Capacity: 300ml. Sizes: ø 11.5cm, h 6cm.

FR Set de 6 bols. Intérieur brillant décoré et Extérieur unicolore mat de 6 couleurs différentes. 6 décors et 6 couleurs différentes. Peut être combiné avec les napperons WD608. Matière: céramique. Contenance: 300ml. Dimensions: ø 11,5 cm, h 6cm.

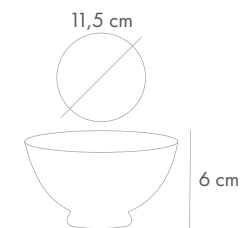

Si lavastoviglie
Dishwasher safe
Lave-vaisselle possible



Si microonde
Microwave safe
Micro-ondes possible



WD610

IT Set di 3 vassoi rettangolari.

In 3 colori e decorazioni differenti. Interno decorato lucido ed esterno monocolor matt. Pratico ed elegante set di vassoi per servire tè, aperitivi e caffè donando un tocco orientale alla vostra tavola. Scopri i diversi possibili abbinamenti con le tovagliette WD lifestyle. Materiale: ceramica. Misure: 31x15cm, 22x12cm, 9,5x7cm.

EN Set of 3 rectangular trays in 3 different colors and decorations. Glossy decorated interior and matt one-color exterior. Practical and elegant set of trays to serve tea, aperitifs and coffee giving an oriental touch to your table. Discover the different possible combinations with WD lifestyle placemats. Material: ceramic. Size: 31x15cm, 22x12cm, 9,5x7cm.

FR Set de 3 plats rectangulaires. Intérieur brillant décoré et Extérieur unicolore mat de 3 couleurs différentes. 3 tailles différentes. Ensemble pratique et élégant de plateaux pour servir le thé, les apéritifs et le café avec une touche orientale à votre table. Découvrez les différentes combinaisons possibles avec les sets de table WD lifestyle. Matière: céramique. Dimensions: 31x15cm, 22x12cm, 9,5x7cm.

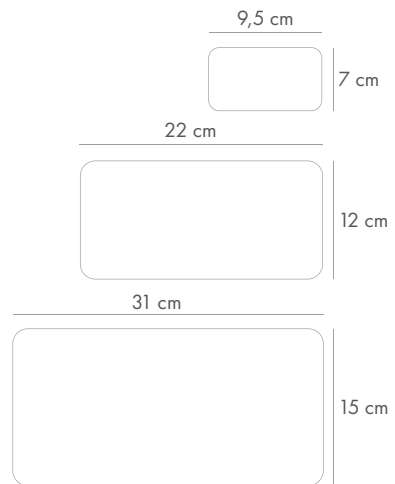

Si lavastoviglie
Dishwasher safe
Lave-vaisselle possible



Si microonde
Microwave safe
Micro-ondes possible





 Si lavastoviglie
 Dishwasher safe
 Lave-vaisselle possible

 Si microonde
 Microwave safe
 Micro-ondes possible

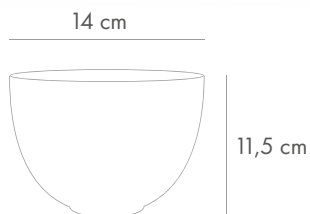

WD611

IT Set 2 ciotole Ramen in due diversi decori, con 2 paia di bacchette in PET.

Interno decorato lucido ed esterno monocolor matt. Questo set è perfetto per dare un tocco di originalità alle tue combinazioni Poke, Ramen e Noodles. Scopri i diversi possibili abbinamenti con le tovagliette WD lifestyle. Materiale: ceramica. Capacità: 800ml. Misure: 14x11,5cm.

EN Set of 2 Ramen bowls in two different decorations, with 2 pairs of PET chopsticks. Glossy decorated interior and matt one-color exterior. This set is perfect for adding a touch of originality to your Poke, Ramen and Noodles combinations. Discover the different possible combinations with WD lifestyle placemats. Material: ceramic. Capacity: 800ml. Size: 14x11,5cm.

FR Set de 2 bols à Ramen avec 2 baguettes en PET. Intérieur brillant décoré et Extérieur unicolore mat de 2 couleurs différentes. Cet ensemble est parfait pour ajouter une touche d'originalité à vos combinaisons de Poke, Ramen et Noodles. Découvrez les différentes combinaisons possibles avec les napperons WD lifestyle. Matière: céramique. Contenance: 800ml. Dimensions: 14x11,5cm.





WD612BL

WD612V

WD612

IT Kit 2 piattini, 2 ciotoline, 2 paia di bacchette in PET e 2 poggia bacchette.

Con interno decorato lucido ed esterno monocolor matt. Questo kit in perfetto stile asiatico, ti consente di portare originalità e autenticità ai tuoi piatti orientali. Scopri i diversi possibili abbinamenti con le tovagliette WD lifestyle. Materiale: ceramica. Misure: 12x12cm, 9,5x7cm, 5x1cm.

EN Kit of 2 saucers, 2 bowls, 2 pairs of PET chopsticks and 2 chopsticks holders, with glossy decorated interior and matt one-color exterior. This kit in perfect Asian style, allows you to bring originality and authenticity to your oriental dishes. Discover the different possible combinations with WD lifestyle placemats. Material: ceramic. Size: 12x12cm, 9,5x7cm, 5x1cm.

FR Ensemble de 2 petits assiettes, 2 bols, 2 paires de baguettes en PET et 2 porte-baguettes. Intérieur brillant décoré et Extérieur unicolore mat. Cet ensemble de style asiatique vous permet d'apporter originalité et authenticité à vos plats asiatiques. Découvrez les différentes combinaisons possibles avec les sets de table WD lifestyle. Matière: céramique. Dimensions: 12x12cm, 9,5x7cm, 5x1cm.



Si lavastoviglie
Dishwasher safe
Lave-vaisselle possible



Si microonde
Microwave safe
Micro-ondes possible



5 cm
11 cm

9,5 cm
7 cm

12 cm

12 cm



WD613AZ

WD613F

WD613

IT Set 2 coppette, 2 paia di bacchette in PET e 2 poggia bacchette in due decorazioni differenti.

Interno decorato lucido ed esterno monocolor matt. Questo set in perfetto stile asiatico, consente di dare originalità e autenticità ai tuoi piatti orientali. Abbinabili alle tovaglie WD608. Materiale coppette: ceramica. Capacità: 300ml. Misure: Ø 11,5cm, h 6cm, 5x1cm.

EN Set of 2 bowls, 2 pairs of PET chopsticks and 2 chopsticks holders in two different decorations. Glossy decorated interior and matt one-color exterior. This set in perfect Asian style, allows you to give originality and authenticity to your oriental dishes. Discover the different possible combinations with WD lifestyle placemats. Cup material: ceramic. Capacity: 300ml. Size: Ø 11,5cm, h 6cm, 5x1cm.

FR Ensemble de 2 tasses, 2 paires de baguettes en PET et 2 porte-baguettes dans deux décorations différentes. Intérieur brillant décoré et Extérieur unicolore mat. Cet ensemble de style asiatique vous permet d'apporter originalité et authenticité à vos plats asiatiques. Matière: porcelaine. Peut être combiné avec les napperons WD608. Matériau de la tasse: céramique. Contenance: 300 ml. Dimensions: Ø 11,5 cm, h 6cm, 5x1cm.



Si lavastoviglie
Dishwasher safe
Lave-vaisselle possible



Si microonde
Microwave safe
Micro-ondes possible

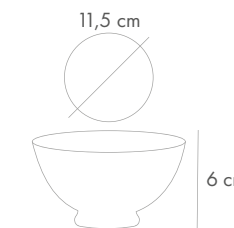



WD608FAR



WD608FBE



WD608PES



WD608FBL



WD608PAP



WD608UCC

WD608

IT Tovaglietta in PVC, ideale per le tue mise en place sia estive che invernali. Per la pulizia utilizzare un panno umido. Dimensioni: 45x30x0,2cm.

EN PVC placemat, ideal for your summer and winter mise en place. Use a damp cloth for cleaning. Dimensions: 45x30x0,2cm.

FR Napperon en PVC, idéal pour votre mise en place en été et en hiver. Utilisez un chiffon humide pour le nettoyage. Dimensions: 45x30x0,2cm.

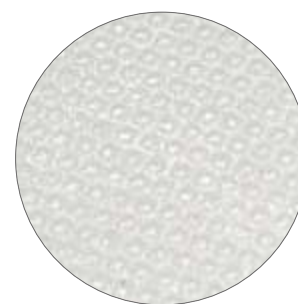
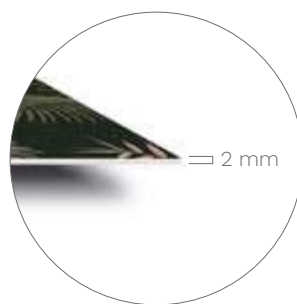

Antiscivolo
Non-slip
Antidérapant



ISTANBUL LINE



WD681R



WD681N



WD681V

WD681

IT Poggia mestolo in ceramica decorato a mano.

É il regalo perfetto per donare un tocco di stile e di personalità alla cucina e rappresenta una soluzione pratica per mantenere pulita la zona di lavoro, proteggendo le superfici da gocce o macchie. Dimensione: L 22,5 l 11 cm H 2,2 cm. Disponibile in 6 varianti di colore: rosso, nero, verde, blu, giallo, turchese.

EN Hand-decorated ceramic ladle holder is the perfect gift to add a touch of style and personality to the kitchen and is a practical solution for keeping the cooking area clean, protecting surfaces from drips or stains. Dimensions: L 22.5 w 11 H 2.2 cm. Available in 6 colours: red, black, green, blue, yellow, turquoise.

FR Porte-louche en céramique décoré à la main est le cadeau idéal pour ajouter une touche de style et de personnalité à la cuisine. Il s'agit d'une solution pratique pour garder la zone de travail propre, en protégeant les surfaces contre les gouttes ou les taches. Dimensions: L 22,5 l 11 H 2,2 cm. Disponible en 6 couleurs: rouge, noir, vert, bleu, jaune, turquoise.



WD681BL



WD681GI



WD681T

**MADE IN
TURKEY**

*Dipinto
a mano*

*Hand
painted*

*Peint à
la main*



Si lavastoviglie
Dishwasher safe
Lave-vaisselle possible

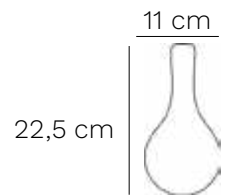

WD671

IT Set di 2 piatti da dessert.

Lavorati e decorati interamente a mano, per regalare alla tua tavola un tocco di vivacità. Disponibile in 3 combinazioni di colori.

EN Set of 2 dessert plates crafted and decorated entirely by hand to give your table a lively touch. Available in 3 color combinations.

FR Set de 2 assiettes à dessert fabriquées et décorées entièrement à la main, pour donner à votre table une touche de vivacité. Disponible en 3 combinaisons de couleurs.



WD672

IT Set di 2 piatti ovali.

Lavorati e decorati interamente a mano, per dare ai tuoi aperitivi un tocco orientale grazie ai colori vivaci e ai décori in rilievo. Disponibile in 2 combinazioni di colori.

EN Set of 2 oval plates crafted and decorated entirely by hand, to give your appetizers an oriental touch thanks to the bright colors and embossed decorations. Available in 2 color combinations.

FR Set de 2 assiettes ovales entièrement fabriquées et décorées à la main, pour donner à vos apéritifs une touche orientale grâce aux couleurs vives et aux décorations en relief. Disponible en 2 combinaisons de couleurs.



Si lavastoviglie
Dishwasher safe
Lave-vaisselle possible



Si microonde
Microwave safe
Micro-ondes possible

**MADE IN
TURKEY**

*Dipinto
a mano*

*Hand painted
Peint à la main*



WD673R

WD673BL



Si lavastoviglie
Dishwasher safe
Lave-vaisselle possible



Si microonde
Microwave safe
Micro-ondes possible

WD673

IT Brocca lavorata e decorate a mano.

Per portare in tavola la vivacità e lo stile dei colori orientali. Capacità 1,5L. Disponibile in 2 colori.

EN Pitcher, handcrafted and hand-decorated to bring the vibrancy and style of oriental colors to the table. 1,5L. capacity. Available in 2 colors.

FR Carafe fabriquée et décorée à la main pour apporter à la table la vivacité et le style des couleurs orientales. Capacité de 1,5L. Disponible en 2 couleurs.

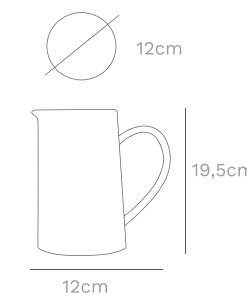



WD622R



WD622V



WD622AZ



WD622AR

**MADE IN
TURKEY**

*Dipinto
a mano*

*Hand
painted*

*Peint à
la main*



WD622

IT Ciotola-Insalatiera in ceramica.

Lavorata e decorata interamente a mano con colori vibranti e decori a rilievo.

EN Bowl in ceramic entirely worked and decorated by hand with vibrant colors and relief decorations.

FR Bol-saladier en céramique travaillé et décoré entièrement à la main avec des couleurs vibrantes et des décorations en relief.



Si lavastoviglie
Dishwasher safe
Lave-vaisselle possible



Si microonde
Microwave safe
Micro-ondes possible



7,5 cm

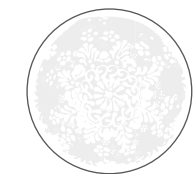

21 cm

MADE IN
TURKEY



*Dipinto
a mano*

*Hand
painted*

*Peint à
la main*

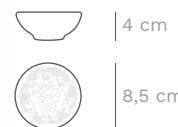

WD621

IT Set 3 coppette lavorate e decorate interamente a mano con colori vibranti e decori a rilievo.

EN Set of 3 cups entirely worked and decorated by hand with vibrant colors and relief decorations.

FR Ensemble de 3 petits bols, entièrement réalisés et décorés à la main avec des couleurs vives et des décorations en relief.



WD623BL



WD623R



WD623GI



WD623V

WD623

IT Mug lavorate e decorate interamente a mano con colori vibranti e decori a rilievo.

EN Mugs entirely worked and decorated by hand with vibrant colors and relief decorations.

FR Mug en céramique en boîte cadeau. Entièrement fabriqué et décoré à la main avec des couleurs vives et une décoration en relief.

8 cm



10 cm





*Dipinto
a mano*



*Hand painted
Peint à la main*



*Dipinto
a mano*

**MADE IN
TURKEY**

*Hand painted
Peint à la main*



WD495AR



WD495AZ



WD495BL



WD495GI



WD495V



WD495R



WD495ME



WD495RA

WD438

IT Set 6 coppette in ceramica multiuso, lavorate a mano interamente e decorate con colori a rilievo. Capacità: 280ml.

EN Set of 6 hand-made ceramic cups entirely decorated with embossed colors. Capacity: 280ml.

FR Set de 6 Coupelles en céramique en boîte cadeau entièrement réalisées à la main et décorées de couleurs en relief. Contenance: 280ml.

 Si lavastoviglie
Dishwasher safe
Lave-vaisselle possible

 Si microonde
Microwave safe
Micro-ondes possible



**MADE IN
TURKEY**

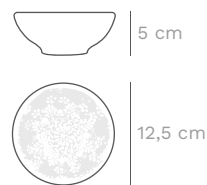

WD495

IT Sottopentola in ceramica lavorato e decorato interamente a mano che regala vivacità alla tua tavola grazie ai colori vibranti ed ai decori a rilievo.

EN Ceramic trivet entirely made and decorated by hand with vibrant colors and embossed decorations giving a happy atmosphere to your table.

FR Dessous-de-plat en céramique fabriqué et décoré à la main qui apporte de l'éclat à votre table grâce à ses couleurs vives et ses décorations en relief.

 No lavastoviglie
No dishwasher
Pas de lave-vaisselle

 No microonde
Nomicrowave
Pas de micro-ondes

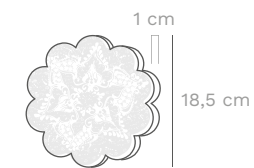

HABANA LINE



WD643

IT Set 4 coppette gelato con paletta in porcellana New Bone Cina.

Coppette arricchite da aforismi che richiamano il gelato. Capacità: 250ml.

EN Set of 4 New Bone China ice cups with spoon. Ice cups enriched with aphorisms that recall the ice cream. Capacity: 250ml.

FR Set 4 bols pour la glace avec palette en porcelaine New Bone China. Bols enrichis d'aphorismes rappelant la glace. Contenance: 250ml.



Si lavastoviglie
Dishwasher safe
Lave-vaisselle possible



Si microonde
Microwave safe
Micro-ondes possible



WD639

IT Set 4 tazze in New Bone China. Coloratissime e arricchite da aforismi che ti faranno iniziare la giornata con il piede giusto. Capacità: 350ml.

EN Set of 4 mugs in New Bone China. Colorful and enriched with aphorisms that will make you start the day on the right foot. Capacity: 350ml.

FR Set de 4 tasses en New Bone China. Colorées et enrichies d'aphorismes pour commencer votre journée du bon pied. Capacité: 350ml.



Si lavastoviglie
Dishwasher safe
Lave-vaisselle possible



Si microonde
Microwave safe
Micro-ondes possible



WD638

IT Set 6 tazzine da caffè in New Bone China. Coloratissime e arricchite da aforismi che ti faranno iniziare la giornata con il piede giusto. Capacità: 100ml.

EN Set of 6 coffee cups in New Bone China. Colorful and enriched with aphorisms that will make you start the day on the right foot. Capacity: 100ml.

FR Set de 6 tasses à café en New Bone China. Colorées et enrichies d'aphorismes qui vous permettront de commencer votre journée du bon pied. Capacité: 100ml.



SINGAPORE LINE

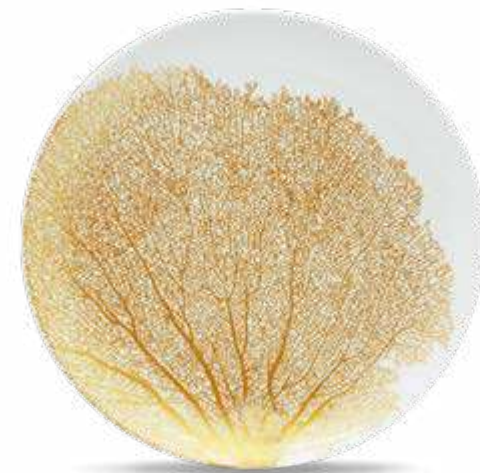

WD540

IT Set 4 piatti in New Bone China con decoro in finitura oro.

Porta in tavola i tuoi cibi con eleganza. Misura: Ø 20,5cm.

EN Set of 4 plates in New Bone China with gold finish decor. Bring your food to the table with elegance. Size: Ø 20,5cm.

FR Set 4 assiettes en New Bone China avec décor en finition or. Apportez vos aliments à la table avec élégance. Dimension: Ø 20,5cm.



Si lavastoviglie
Dishwasher safe
Lave-vaisselle possible



Si microonde
Microwave safe
Micro-ondes possible

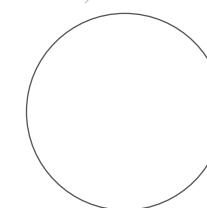



WD541

IT Set 4 ciotole in ceramica con decoro in finitura oro.

Porta in tavola i tuoi cibi con eleganza. Misure: Ø 15,3cm, h 6cm.

EN Set of 4 bowls in black ceramic with gold finish decor.

Bring your food to the table with elegance. Sizes: Ø 15,3cm, h 6cm.

FR Ensemble de 4 bols en céramique avec une décoration en finition dorée.

Apportez votre nourriture à la table avec élégance. Dimensions: Ø 15,3cm, h 6cm.



Si lavastoviglie
Dishwasher safe
Lave-vaisselle possible



Si microonde
Microwave safe
Micro-ondes possible



WD542

IT Set 4 piatti quadrati in ceramica con decoro in finitura oro.

Porta in tavola i tuoi cibi con eleganza. Misure: 21cm x 21cm.

EN Set 4 square plates in black ceramics with a gold finish decor.

Bring your food to the table with elegance. Size: 21cm x 21cm.

FR Set de 4 assiettes carrées en céramique avec une décoration en finition dorée.
Apportez votre nourriture à la table avec élégance. Dimensions: 21cm x 21cm

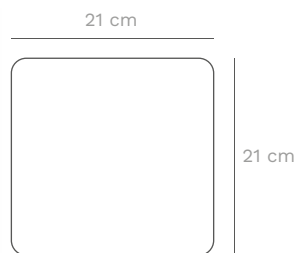



WD595B



WD595N

TISANIERA | MUG | TISANIÈRE
 Si lavastoviglie
 Dishwasher safe
 Lave-vaisselle possible

 Si microonde
 Microwave safe
 Micro-ondes possible

FILTRO | FILTER | FILTRE
 Si lavastoviglie
 Dishwasher safe
 Lave-vaisselle possible
 No microonde
 Nomicrowave
 Pas de micro-ondes

Filtro in acciaio
SS filter
Filtre en acciaio

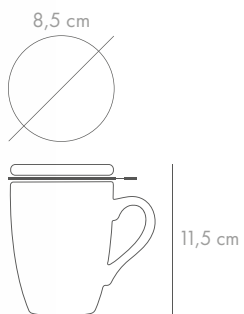

WD595

IT Tisaniera in New Bone China (versione bianca) o **ceramica** (versione nera) con decoro in finitura oro, filtro in acciaio e coperchio. Capacità: 330ml.

EN New Bone China (white version) or **ceramic** (black version) mug with gold finish decoration, stainless steel filter and lid. Capacity: 330ml.

FR Tisanière en New Bone China (version blanche) ou **céramique** (version noire) avec décor en finition or, filtre en acier et couvercle. Contenance: 330ml.



WD539N



WD539B

WD539

IT Set 2 tazze in ceramica (versione nera) o **New Bone China** (versione bianca) **con decoro in finitura oro**. Vivi con eleganza i tuoi momenti di pausa. Capacità: 330ml

EN Set 2 mugs in ceramic (black version) or in **New Bone China** (white version) with gold finish decor. Live your break with elegance. Capacity: 330ml.

FR Set 2 tasses en céramique (version noire) ou **New Bone China** (version blanche) avec décor en finition or. Vivez avec élégance vos moments de pause. Contenance: 330ml

 Si lavastoviglie
 Dishwasher safe
 Lave-vaisselle possible

 Si microonde
 Microwave safe
 Micro-ondes possible

LINEA OSAKA



WD706

IT Teiere in ghisa resistenti e raffinate, permettono un'ottima conduzione di calore e lo preservano per diverse ore. Se si usa per bollire l'acqua è consigliabile togliere il filtro durante la bollitura ed usare uno spargi fiamma da interporre tra la teiera e la fiamma del gas. Disponibile in 4 varianti di colore: grigio, antracite, bianco, verde.

EN Durable and refined cast iron teapots that allow excellent heat conduction and preserve it for several hours. If you use it to boil water, it is advisable to remove the filter while boiling and use a flame spreader to be placed between the teapot and the gas flame. Available in 4 colour variants: grey, anthracite, white, green.

FR Théières en fonte, durables et raffinées, permettent une excellente conduction de la chaleur et la conservent pendant plusieurs heures. Si vous l'utilisez pour faire bouillir de l'eau, il est conseillé de retirer le filtre pendant l'ébullition et d'utiliser un répartiteur de flamme à placer entre la théière et la flamme du gaz. Disponible en 4 couleurs: gris, anthracite, blanc, vert.



WD706G

Capacità 800ml
Capacity 800ml
Contenance 800ml



WD706AN

Capacità 800ml
Capacity 800L
Contenance 800L



WD706B

Capacità 1,2L
Capacity 1,2L
Contenance 1,2L



WD706V

Capacità 1,3L
Capacity 1,3L
Contenance 1,3L



No lavastoviglie
No dishwasher
Pas de lave-vaisselle



No microonde
Nomicrowave
Pas de micro-ondes



Per la cottura sui fornelli si consiglia l'ausilio di uno spargifiamma
Il est recommandé d'utiliser un diffuseur de flamme pour la cuisson sur la cuisinière
For cooking on the stove, the use of a flame spreader is recommended



WD458BL
600ml



WD458F
500ml



WD458B
500ml



WD458AZ
600ml



Per la cottura sui fornelli si consiglia l'ausilio di uno spargifiamma
Il est recommandé d'utiliser un diffuseur de flamme pour la cuisson sur la cuisinière
For cooking on the stove, the use of a flame spreader is recommended



No lavastoviglie
No dishwasher
Pas de lave-vaisselle



No microonde
Nomicrowave
Pas de micro-ondes

WD458

IT Teiere in ghisa arricchite da raffinati dettagli color oro che le rendono ancora più uniche e ricercate. Lo spessore uniforme delle teiere in ghisa conferiscono un'ottima conduzione di calore e lo preservano in maniera unica. Se si usa la teiera per bollire l'acqua, è consigliabile rimuovere il filtro durante la bollitura ed usare uno spargifiamma da interporre fra la teiera e la fiamma del gas.

EN The homogenous thickness of the cast iron teapots gives excellent heat conduction and preservation. If the pot is used to boil water on the stove, it is recommended to remove the filter and to use a fire net in between your pot and the flame to disperse the direct heat.

FR Théière en fonte avec relief doré. L'épaisseur uniforme des théières en fonte permet une excellente conduction de la chaleur et la conserve d'une manière unique. Si vous utilisez la théière pour faire bouillir de l'eau, il est conseillé de retirer le filtre pendant l'ébullition et d'utiliser un diffuseur de flamme entre la théière et la flamme du gaz. Fournie avec un filtre inox. Poignée dorée et inclinable. Intérieur émaillé.

WD430

IT Set teiera con filtro (800ml) + 4 bicchieri (100ml) in ghisa in colore grigio con texture rossa a rilievo.

EN Teapot with filter (800ml) + 4 cups (100ml) in cast iron material in grey colour color with embossed red reliefs.

FR Ensemble de théière avec filtre (800ml) + 4 verres (100ml) en fonte grise avec texture en relief rouge.



No lavastoviglie
No dishwasher
Pas de lave-vaisselle



No microonde
Nomicrowave
Pas de micro-ondes



WD431

IT Set teiera con filtro (1000ml) + 4 bicchieri (100ml) in ghisa in colore viola con texture orizzontale a rilievo.

EN Teapot with filter (1000ml) + 4 cups (100ml) in cast iron material in purple colour color with embossed red reliefs.

FR Théière avec filtre (1000ml) + 4 verres (100ml) en fonte violette avec texture horizontale en relief.



CARATTERISTICHE:

La storia della fusione della ghisa in Giappone è antichissima e risale almeno alla fine dell'XI secolo. Questi prodotti tradizionali in ghisa mostrano una bellezza e una maestria degne di trasformare il momento del tè in una vera e propria arte. Lo spessore uniforme delle teiere in ghisa conferisce un'ottima conduzione di calore e lo preserva in maniera unica. Se si usa la teiera per bollire l'acqua, è consigliabile rimuovere il filtro durante la bollitura e usare uno spargifiamma da interporre fra la teiera e la fiamma del gas.

WD432

IT Set teiera con filtro (500ml) + 4 bicchieri (50ml) in ghisa in colore blu con texture colore oro a rilievo.

EN Teapot with filter (500ml) + 4 cups (50ml) in cast iron material in blue colour with embossed gold reliefs.

FR Ensemble de théière avec filtre (500ml) + 4 verres (50ml) en fonte de couleur bleue avec texture en relief dorée.



WD433

IT Set teiera con filtro (600ml) + 4 bicchieri (50ml) in ghisa in colore rosso con texture a rilievo.

EN Teapot with filter (600ml) + 4 cups (50ml) in cast iron material in red colour with embossed reliefs.

FR Ensemble de théière avec filtre (600ml) + 4 verres (50ml) en fonte de couleur rouge avec texture en relief.



Per la cottura sui fornelli si consiglia l'ausilio di uno spargifiamma
Il est recommandé d'utiliser un diffuseur de flamme pour la cuisson sur la cuisinière
For cooking on the stove, the use of a flame spreader is recommended



No lavastoviglie
No dishwasher
Pas de lave-vaisselle



No microonde
Nomicrowave
Pas de micro-ondes

FEATURES:

The ancient history of cast iron in Japan dates back to end of the 11th century. These traditional cast iron products show a beauty and a mastery worthy of transforming the tea break into real art. The homogenous thickness of the cast iron teapots gives excellent heat conduction and preservation. If the pot is used to boil water on the stove, it is recommended to remove the filter and to use a fire net in between your pot and the flame to disperse the direct heat.

CARACTÉRISTIQUES:

L'histoire de la fonte au Japon est très ancienne et remonte au moins à la fin du XIe siècle. Ces produits traditionnels en fonte affichent une beauté et un savoir-faire dignes de faire de l'heure du thé un véritable art. L'épaisseur uniforme des théières en fonte permet une excellente conduction de la chaleur et la conserve d'une manière unique. Si la théière est utilisée pour faire bouillir de l'eau, il est conseillé d'enlever le filtre pendant l'ébullition et d'utiliser un diffuseur de flamme à placer entre la théière et la flamme du gaz.

KAFFA LINE

Kaffa è considerata la terra nativa del caffè. Si ritiene infatti che la parola caffè derivi proprio da Kaffa (anche Caffa o Kafa), la regione sud occidentale dell'Etiopia in cui la pianta cresceva spontaneamente.

Kaffa is considered the homeland of coffee. It is believed that the word "coffee" derives from Kaffa (also Caffa or Kafa), the south-western region of Ethiopia where the plant grew spontaneously.

Kaffa est considérée comme la terre natale du café. On pense en effet que le mot café provient précisément de Kaffa (également Caffa ou Kafa), la région sud-ouest de l'Éthiopie où la plante poussait spontanément.





WD504

IT Barattolo in vetro borosilicato con coperchio in plastica e anello in silicone.

L'innovativo tappo può essere fatto scorrere internamente al barattolo consentendo di limitare l'aria all'interno dello stesso trattenendo così al meglio tutti gli aromi e mantenendo fresco il contenuto. Ideale per riporre chicchi di caffè, caffè macinato oppure tè e infusi. Capacità: 510ml. Misure: 10x10cm.

EN Borosilicate glass jar with plastic lid and silicone ring. The innovative cap can be slid inside the jar, allowing you to limit the air inside it, thus retaining all the aromas and keeping the contents fresh. Ideal for storing coffee beans, ground coffee or tea and infusions. Capacity: 510ml. Size: 10x10cm.

FR Pot en verre borosilicate avec couvercle en plastique et anneau en silicone. Le bouchon innovant peut être glissé à l'intérieur du bocal, ce qui permet de restreindre l'air à l'intérieur du bocal et de conserver tous les arômes et de garder le contenu frais. Idéal pour conserver les grains de café, le café moulu ou le thé et les infusions. Contenance: 510ml. Dimensions: 10x10cm.

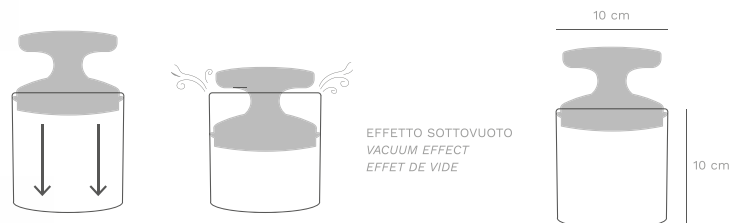

EFFETTO SOTTOVUOTO
VACUUM EFFECT
EFFET DE VIDE



Si lavastoviglie
Dishwasher safe
Lave-vaisselle possible



No microonde
Nomicrowave
Pas de micro-ondes



WD505

IT Barattolo in vetro borosilicato con coperchio in plastica e anello in silicone.

L'innovativo tappo può essere fatto scorrere internamente al barattolo consentendo di limitare l'aria all'interno dello stesso trattenendo così al meglio tutti gli aromi e mantenendo fresco il contenuto. Ideale per riporre chicchi di caffè, caffè macinato oppure tè e infusi. Capacità: 940ml. Misure: 10x15cm.

EN Borosilicate glass jar with plastic lid and silicone ring. The innovative cap can be slid inside the jar, allowing you to limit the air inside it, thus retaining all the aromas and keeping the contents fresh. Ideal for storing coffee beans, ground coffee or tea and infusions. Capacity: 940ml. Size: 10x15cm.

FR Pot en verre borosilicate avec couvercle en plastique et anneau en silicone. Le bouchon innovant peut être glissé à l'intérieur du bocal, ce qui permet de restreindre l'air à l'intérieur du bocal et de conserver tous les arômes et de garder le contenu frais. Idéal pour conserver les grains de café, le café moulu ou le thé et les infusions. Contenance: 940ml. Dimensions: 10x15cm.

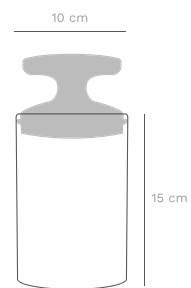



WD496

IT Bollitore elettrico in vetro borosilicato con inserti in finitura opaca. Dotato di display che segnala la temperatura dell'acqua. Grazie alla possibilità di impostare i gradi, questo è il prodotto ideale per la preparazione di alcune tipologie di tè, dove l'acqua necessita di essere portata ad una determinata temperatura. Le luci LED cambiano di colore al raggiungimento delle varie temperature. Base con salvaspazio per il cavo. Bollitore ruotante a 360° su base. Capacità:1,7L. Potenza: 1850-2200W.

EN Electric kettle in borosilicate glass with matt finish inserts. Equipped with a display that shows the water temperature. Thanks to the possibility of setting the degrees, it is the ideal product for the Preparation of some types of tea, in which the water needs to be brought a certain temperature. The LED lights change color when the various temperatures are reached. Base with space-saving cable. 360 ° rotating kettle on the base. Capacity: 1,7L. Power: 1850-2200W

FR Bouilloire électrique en verre borosilicate avec inserts en finition mate. Équipé d'un écran qui indique la température de l'eau. Grâce à la possibilité de régler les degrés, c'est le produit idéal pour la préparation de certains types de thé, où l'eau doit être portée à une certaine température. Les lumières LED changent de couleur lorsque les différentes températures sont atteintes. Base avec économiseur d'espace pour le câble. La bouilloire tourne à 360° sur la base. Contenance: 1,7L. Puissance: 1850-2200W.

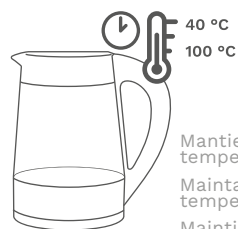

Mantiene la temperatura
Maintaining the temperature
Maintien de la température

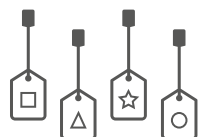

Temperature differenti per tè differenti
Different temperatures for different teas
Différentes températures pour différents thés



SENZA BISFENOLO
WITHOUT BISPENOL
SANS BISPHÉNOL



16 colorazioni LED
16-color LED light
Lumière LED 16 couleurs



No lavastoviglie
No dishwasher
Pas de lave-vaisselle



No microonde
Nomicrowave
Pas de micro-ondes





WD498

IT Cappuccinatore elettrico pratico e versatile per preparare una deliziosa schiuma di latte densa e cremosa in pochi secondi. Realizzato in vetro borosilicato con inserti in finitura opaca nera. Recipiente in vetro. Il cappuccinatore può scaldare il latte e creare una schiuma come al bar. Diversamente, senza azionare la modalità riscaldante, può essere preparata una schiuma fredda. Tasto on/off e doppio clic per modalità caldo con indicatore a luce led rossa. Funzionamento ad induzione. Indicatore di livello MIN e MAX sul recipiente. Potenza: 600W

EN Prepare a delicious, thick and creamy milk foam in a few seconds with this practical and versatile electric milk frother. Made of borosilicate glass with black matte finish inserts. Glass container, dishwasher safe. This milk frother can heat the milk and create a hot foam like at the bar. Otherwise, without operating the heating mode, a cold foam can be prepared. On / off button and double click for hot mode with red led light indicator. Induction operation. MIN and MAX level indicator. Power: 600W

FR Emulsionneur de lait électrique Pratique et simple pour préparer une mousse de lait épaisse et crémeuse, froide ou chaude. Récipient en verre borosilicate. Bouton marche/arrêt et double-clic pour le mode chaud indiqué par LED rouge. Température maxi: 62°C. Puissance 600W.



Mod. montatura a caldo
Hot froth mode
Mode de montage à chaud



Testina per montare
Frothing whisk
Tête de montage



Mod. montatura a freddo
Cold froth mode
Mode de montage à froid



Testina per scaldare
Heating whisk
Tête de chauffage

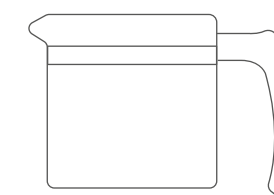

BROCCA | PITCHER | CARAFE



Si lavastoviglie
Dishwasher safe
Lave-vaisselle possible



No microonde
Nomicrowave
Pas de micro-ondes

WD502

IT Set in vetro borosilicato per la preparazione del caffè.

Caffè estratto a freddo: chiamato anche Cold Brew coffee. Questo metodo di estrazione a freddo, che richiede tempi molto lunghi (8h circa), consente di ottenere un caffè con bassa acidità e con una dolcezza eccellente grazie alla temperatura dell'acqua, che non estrae le sostanze amare dal caffè e limita la caffeina. Il caffè ottenuto ha la possibilità di essere conservato anche per 2/3 giorni in frigorifero, pertanto si può prepararne anche in grandi quantità alla volta. Lo strumento utilizzato si compone di 3 parti:

- Una parte superiore in vetro borosilicato (e relativo coperchio in acciaio) dove inserire il ghiaccio o l'acqua fredda (o l'insieme delle due) a seconda del grado di gocciolamento e dunque dell'estrazione che si vuole ottenere.

- Un filtro in acciaio da riempire con il caffè macinato. La scelta del caffè da utilizzare influisce sul risultato della bevanda ottenuta. Solitamente si utilizzano preferibilmente miscele molto fruttate e aromatiche, tipiche dell'Africa Orientale (Etiopia o Kenya). Ognuno può incontrare il proprio gusto miscelando diverse tipologie di caffè.

- Ultimo componente è il contenitore in vetro borosilicato. Questa caraffa, con capacità 950ml, può essere utilizzata (con il coperchio in acciaio) per riporre il caffè ottenuto dopo l'estrazione per essere poi degustato anche con l'aggiunta di aromi, latte di mandorla, ghiaccio o panna. Può dunque essere degustato freddo, a temperatura ambiente o shakerato. Le caratteristiche dell'estrazione a freddo rendono facile l'abbinamento del caffè con distillati per la creazione di cocktail originali. Un abbinamento classico è quello con il gin e la tonica.

Caffè estratto a caldo: è il classico caffè all'americana dove la preparazione consiste nel riempire la parte superiore con acqua calda/bollente ed ottenere così un caffè lungo. La quantità di caffè all'interno del filtro crea un caffè più o meno intenso. La miscela ideale per ottenere un buon caffè all'americana è caratterizzata da note leggermente tostate, fresche e non troppo amare.

Caffè estratto a freddo / Cold brew coffee:

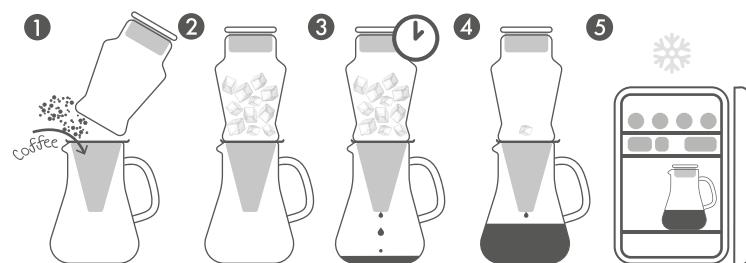

EN Set in borosilicate glass for coffee preparation:

also called Cold-brew coffee. This cold-brewed coffee method requires a very long time to be prepared (about 8h), it allows you to obtain a coffee low in acidity and characterized by a fantastic sweetness thanks to the water temperature, that does not extract the bitter substances from the coffee and limits the caffeine quantity. The coffee obtained can be stored for up to 2/3 days in the refrigerator, so it can also be prepared in large quantities. The infuser is composed of 3 parts:

- An upper part in borosilicate glass (and relative steel cover) where to insert ice or cold water (or both) depending on the Degree of dripping and therefore on the extraction..

- A steel filter to be filled with ground coffee. The different types of coffee you use influence the taste of the final drink. By mixing different types of coffee, everyone can meet their preferred taste. Everyone can meet their taste by mixing different types of coffee.

- The last component is the borosilicate glass container. This jug, with capacity 950ml, can be used (with the steel lid) to store the coffee obtained after extraction and then savored with the addition of aromas, almond milk, ice or cream. It can therefore be tasted cold, at room temperature or shaken. The characteristics of cold extraction make it easy to combine it with distillates, in order to create original cocktails. A classic is gin and tonic combination. .

Hot-drawn coffee: This is the classic American coffee, in which the preparation consists of filling the top with hot/boiling water and obtaining a long coffee. The amount of coffee inside the filter creates a more or less intense coffee. The ideal mixture to obtain a good American coffee is characterized by slightly toasted and not too bitter notes.

Caffè estratto a caldo / Hot-drawn coffee:

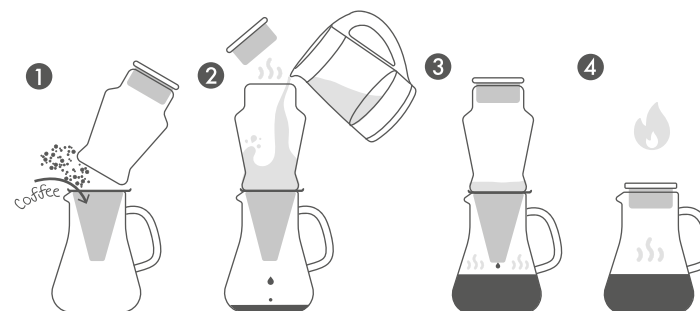

FR Set en verre borosilicate pour la préparation du café.

Le café filtré à froid: également appelé "Cold Brew coffee". Cette méthode d'extraction à froid, qui prend beaucoup de temps (environ 8h), permet d'obtenir un café peu acide et très doux grâce à la température de l'eau qui n'extrait pas les substances amères du café et limite la caféine. Le café obtenu peut également être conservé pendant 2/3 jours au réfrigérateur, il peut donc aussi être préparé en grande quantité à la fois. L'instrument utilisé se compose de 3 parties:

- Une partie supérieure en verre borosilicate (et son couvercle en acier) où l'on insère des glaçons ou de l'eau froide (ou une combinaison des deux) en fonction du degré d'égouttage et donc de l'extraction que l'on souhaite obtenir.

- Un filtre en acier à remplir de café moulu. Le choix du café à utiliser influence le résultat de la boisson obtenue. On préfère généralement les mélanges très fruités et aromatiques, typiques de l'Afrique de l'Est (Éthiopie ou Kenya). Chacun peut satisfaire son propre goût en mélangeant différents types de café.

- Le dernier composant est le récipient en verre borosilicate. Cette carafe, d'une contenance de 950ml, peut être utilisée (avec le couvercle en acier) pour conserver le café après extraction pour être dégusté avec l'ajout d'arômes, de lait d'amande, des glaçons ou de crème. Il peut donc être dégusté froid, à température ambiante ou secoué. Les caractéristiques de l'extraction à froid permettent de combiner facilement le café avec des spiritueux pour créer des cocktails originaux. L'association classique est le gin et le tonic.

Café filtré à chaud: il s'agit du café classique à l'américaine dont la préparation consiste à remplir le sommet avec de l'eau chaude/bouillante et à obtenir ainsi un café long. La quantité de café à l'intérieur du filtre permet de créer un café plus ou moins intense. Le mélange idéal pour un bon café à l'américaine se caractérise par des notes légèrement torréfiées, fraîches et pas trop amères.



GUARDA IL VIDEO
WATCH THE VIDEO
REGARDEZ LA VIDÉO



Si lavastoviglie
Dishwasher safe
Lave-vaisselle possible



No microonde
Nomicrowave
Pas de micro-ondes



WD500

IT Set 2 bicchierini da caffè in vetro borosilicato a doppia camera. Ideali per godersi un buon caffè in compagnia e con originalità. Grazie alle caratteristiche del vetro borosilicato, questi bicchierini resistono ad alte e basse temperature e la doppia parete mantiene più a lungo la temperatura. È consigliabile il lavaggio a mano. Capacità: 70ml.

EN Set of 2 double-wall coffee cups in borosilicate glass. Ideal for enjoying a good coffee with originality. Thanks to the characteristics of borosilicate glass, these glasses support high and low temperatures and the double-wall glass keeps the temperature longer. Hand washing is recommended. Capacity: 70ml.

FR Set de 2 petits verres à café en verre borosilicate à double paroi. Idéal pour déguster un bon café en compagnie et avec originalité. Grâce aux caractéristiques du verre borosilicate, ces gobelets résistent aux hautes et basses températures et la double paroi maintient la température plus longtemps. Le lavage à la main est recommandé. Contenance: 70ml.



Si lavastoviglie
Dishwasher safe
Lave-vaisselle possible



Si microonde
Microwave safe
Micro-ondes possible



WD501

IT Set 2 bicchieri in vetro borosilicato a doppia camera. Ideali per godersi un buon caffè o una gustosa bevanda in compagnia e con originalità. Grazie alle caratteristiche del vetro borosilicato, questi bicchieri resistono ad alte e basse temperature e la doppia parete mantiene più a lungo la temperatura. È consigliabile il lavaggio a mano. Capacità: 325ml.

EN Set of 2 double-wall glasses in borosilicate glass. Ideal for enjoying a good coffee or a tasty drink with originality. Thanks to the characteristics of borosilicate glass, these glasses support high and low temperatures and the double-wall glass keeps the temperature longer. Hand washing is recommended. Capacity: 325ml.

FR Set de 2 verres à café en verre borosilicate à double paroi. Idéal pour déguster un bon café en compagnie et avec originalité. Grâce aux caractéristiques du verre borosilicate, ces gobelets résistent aux hautes et basses températures et la double paroi maintient la température plus longtemps. Le lavage à la main est recommandé. Contenance: 325ml.

MONOLITE LINE

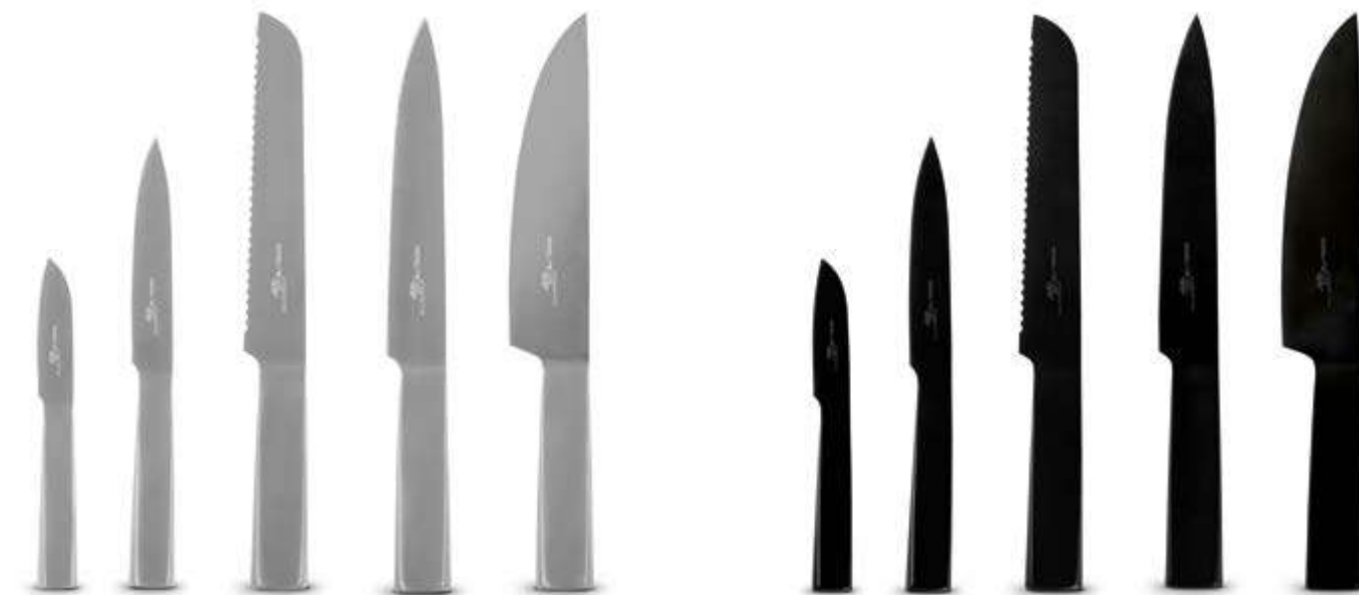
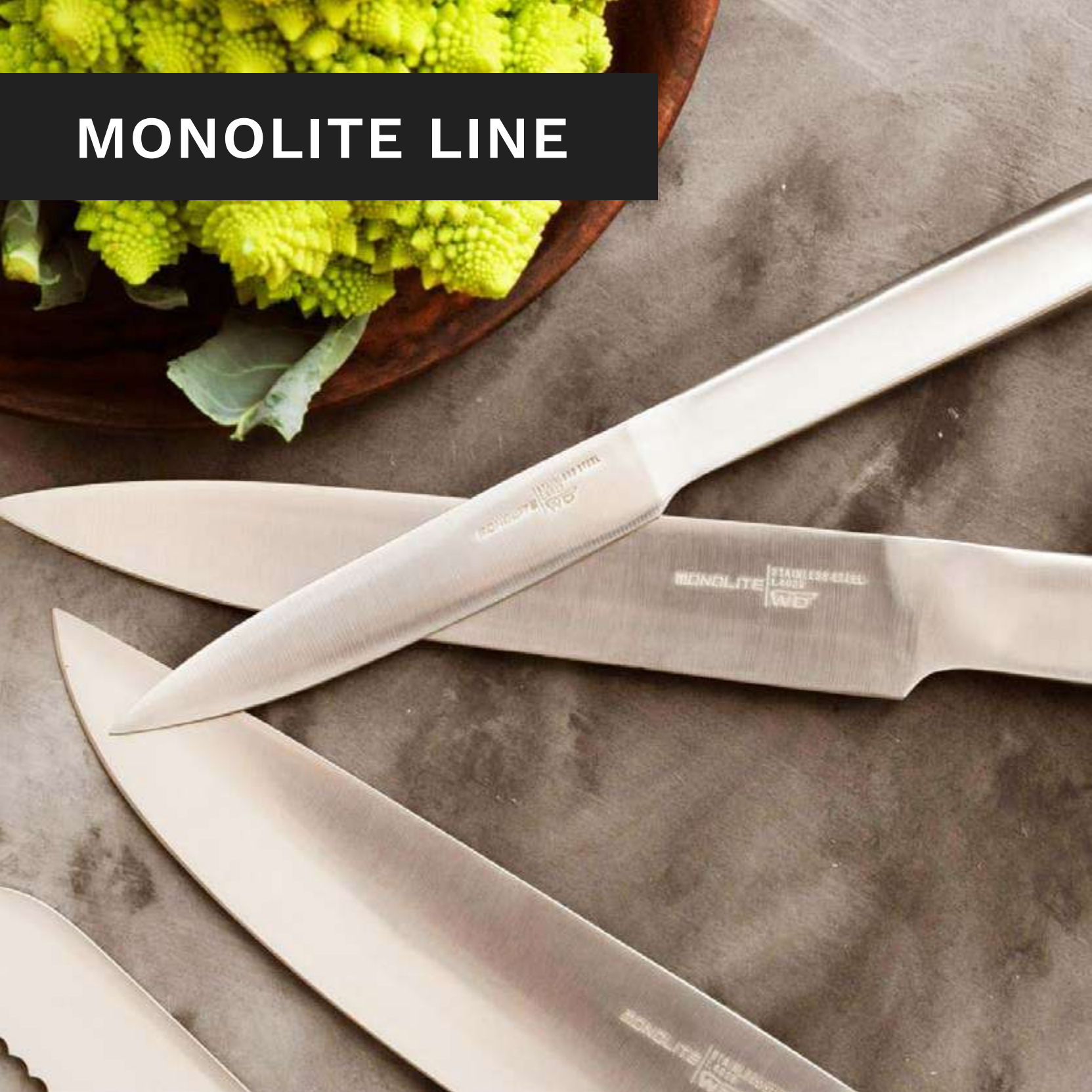

WD486A

WD486N

WD486

IT Set 5 coltelli forgiati in acciaio inox 1.4028 con logo MONOLITE impresso nella lama. Composto da coltello cucina, arrosto, pane, multiuso e spelucchino. Coltelli con molatura conica dallo stile elegante e minimalista. In confezione regalo.

EN Set of 5 1.4028 stainless steel forged knives with MONOLITE logo embossed on the blade. Set composed by chef, carving, bread, utility and paring knives. The tapered sanding gives an elegant and elegant and minimal touch to the blades.

FR Ensemble de 5 couteaux forgés en acier inoxydable 1.4028 avec le logo MONOLITE en relief sur la lame. Composé d'un couteau de cuisine, d'un couteau pour des rôtis, d'un couteau à pain, d'un couteau multiusage et d'un couteau d'office. Couteaux de style élégant et minimaliste avec affûtage conique. Dans une boîte cadeau.

Disponibili in finitura acciaio o finitura con rivestimento antiaderente opaco nero.
Available in Stainless steel finishing or matt black non-stick coating.
Disponible en finition acier ou en finition avec revêtement antiadhésif noir mat.



Si lavastoviglie
Dishwasher safe
Lave-vaisselle possible



WD487A



WD487N

WD487

IT Set 6 coltelli bistecca forgiati in acciaio inox 1.4028 con logo MONOLITE impresso nella lama. Coltelli con molatura conica dallo stile elegante e minimalista in confezione regalo.

EN Set of 6 1.4028 stainless steel forged steak knives in black color with MONOLITE logo embossed on the blade. The tapered sanding gives an elegant and elegant and minimal touch to the blades.

FR Set de 6 couteaux à steak forgés en acier inoxydable 1.4028 avec le logo MONOLITE en relief sur la lame. Couteaux à affûtage conique de style élégant et minimaliste dans une boîte cadeau.

Disponibili in finitura acciaio o finitura con rivestimento antiaderente opaco nero.
Available in Stainless steel finishing or matt black non-stick coating.
Disponible en finition acier ou en finition avec revêtement antiadhésif noir mat.



Si lavastoviglie
Dishwasher safe
Lave-vaisselle possible



INDICE ARTICOLI | ARTICLES INDEX | INDEX DES ARTICLES:

CODICE	PAG.	CODICE	PAG.	CODICE	PAG.	CODICE	PAG.	CODICE	PAG.	CODICE	PAG.	CODICE	PAG.
WD018B	212	WD365NOTTE	139	WD424	223	WD506CO	136	WD566DEL	57	WD572	224	WD608PES	262
WD018BEI	212	WD365ONDA	141	WD430	288	WD506LET	136	WD566ELE	58	WD573	224	WD608UCC	262
WD018BLACK	212	WD365PAP	140	WD431	288	WD506MAN	136	WD566FAR	61	WD574GOLD	200	WD609	253
WD018BLU	212	WD365PAVONE	141	WD432	289	WD506ME	136	WD566FEN	59	WD574N	200	WD610	254
WD018BOR	212	WD365PES	140	WD433	289	WD506SQU	136	WD566FRA	62	WD574SILVER	200	WD611	256
WD018DAB	211	WD365PETROLIO	139	WD438	272	WD518	146	WD566FUN	59	WD575ANT	143	WD612BL	259
WD018DAG	211	WD365R	138	WD440T	213	WD523N	227	WD566GAB	58	WD575AZ	143	WD612V	259
WD018DAM	211	WD365RO	138	WD458AZ	287	WD523R	227	WD566GAL	58	WD575CO	143	WD613AZ	261
WD018FOG	211	WD365SA	138	WD458B	287	WD523S	227	WD566GAT	54	WD575LIL	143	WD613F	261
WD018GOLD	212	WD365SILVER	139	WD458BL	287	WD525B	149	WD566GEC	53	WD575TER	143	WD615	88
WD018KAS	211	WD365SUS	140	WD458F	287	WD525BL	149	WD566GIR	61	WD575V	143	WD617GOLD	188
WD018MAIO	211	WD365TAT	141	WD474B	142	WD525MANDARINO	149	WD566GRA	57	WD577B	238	WD617SILVER	188
WD018PET	211	WD365TIG	141	WD474BL	142	WD525PETROLIO	149	WD566GUF	59	WD577C	238	WD618AZ	150
WD018RED	212	WD365UCC	140	WD474G	142	WD525R	149	WD566KOA	53	WD577F	238	WD618GI	150
WD018SILVER	212	WD365V	138	WD474GI	142	WD535	144	WD566LIM	62	WD577T	238	WD618V	150
WD018VIN	211	WD365ZEB	141	WD474MAT	142	WD537B	187	WD566LUC	63	WD579	221	WD619B	199
WD173	87	WD405AM	175	WD474N	142	WD537CA	186	WD566MAN	50	WD580G	206	WD619N	199
WD174	87	WD405AVI	175	WD474OL	142	WD537G	187	WD566MAR	61	WD580GI	206	WD621	270
WD318	87	WD405BL	175	WD474PET	142	WD537MAT	186	WD566MED	57	WD580N	206	WD622AR	269
WD319	87	WD405GOLD	183	WD474R	142	WD537N	187	WD566MEL	62	WD580R	206	WD622AZ	269
WD365APE	140	WD405M	175	WD475A	233	WD537PA	186	WD566ORA	55	WD581	193	WD622R	269
WD365AR	138	WD405R	175	WD475B	233	WD537PET	187	WD566ORR	55	WD585ANC	69	WD622V	269
WD365ARA	140	WD405T	175	WD475TR	233	WD537SEN	186	WD566PAN	53	WD585ANG	69	WD623BL	270
WD365AZ	138	WD405TR	175	WD477A	231	WD539B	283	WD566PAP	59	WD585FOC	69	WD623GI	270
WD365B	139	WD405V	175	WD477B	231	WD539N	283	WD566PAPE	59	WD586	237	WD623R	270
WD365BA	138	WD406AM	177	WD477TR	231	WD540	279	WD566PEC	53	WD587	216	WD623V	270
WD365BEA	140	WD406AVI	177	WD478A	233	WD541	280	WD566PEL	53	WD588	216	WD624BL	78
WD365BL	139	WD406BL	177	WD478B	233	WD542	280	WD566PEP	50	WD589	218	WD624GI	78
WD365CANI	140	WD406GOLD	183	WD478TR	233	WD550	146	WD566POL	57	WD591	228	WD624V	78
WD365CE	139	WD406M	177	WD480	227	WD555LIME	147	WD566QUA	50	WD592	229	WD625BL	81
WD365CO	138	WD406R	177	WD486A	303	WD555MAGENTA	147	WD566RAN	59	WD593	228	WD625GI	81
WD365COR	140	WD406T	177	WD486N	303	WD555MANDARINO	147	WD566RIN	53	WD594	229	WD625V	81
WD365COS	140	WD406TR	177	WD487A	304	WD555N	147	WD566SAC	50	WD595B	282	WD626BL	82
WD365F	139	WD406V	177	WD487N	304	WD555NOTTE	147	WD566SCA	63	WD595N	282	WD626GI	82
WD365FIO	140	WD407AM	178	WD495AR	273	WD564ARA	73	WD566SQU	57	WD596B	98	WD626V	82
WD365FOGLIE	141	WD407AVI	178	WD495AZ	273	WD564BAL	72	WD566STE	57	WD596V	98	WD627BL	83
WD365FRU	140	WD407BL	178	WD495BL	273	WD564QUA	73	WD566TAR	59	WD597	97	WD627GI	83
WD365G	139	WD407GOLD	183	WD495GI	273	WD564SOT	73	WD566TUC	53	WD598	95	WD627V	83
WD365GATTI	140	WD407M	178	WD495ME	273	WD565CIL	71	WD566TUL	61	WD599GI	101	WD628B	202
WD365GC	138	WD407R	178	WD495R	273	WD565CUO	71	WD566UVA	59	WD599V	101	WD628N	202
WD365GI	138	WD407T	178	WD495RA	273	WD565NIN	70	WD566VOL	58	WD600	102	WD629BE	204
WD365GIR	140	WD407TR	178	WD495V	273	WD565PES	71	WD566ZUC	59	WD601B	102	WD629BL	204
WD365JUNGLE	141	WD407V	178	WD496	294	WD566ALL	53	WD569	153	WD602	102	WD629N	204
WD365KIT	145	WD408AM	180	WD498	297	WD566APE	61	WD570B	148	WD603	94	WD632	84
WD365LILLA	139	WD408AVI	180	WD500	301	WD566ARA	61	WD570BL	148	WD604	94	WD633CAN	67
WD365LIME	138	WD408BL	180	WD501	301	WD566BOR	63	WD570R	148	WD605	92	WD633CER	67
WD365MAGENTA	139	WD408GOLD	183	WD502	298	WD566CAN	54	WD571BE	243	WD606	91	WD633CUP	64
WD365MAIO	141	WD408M	180	WD504	292	WD566CAV	57	WD571DECR	240	WD607	220	WD633GAT	67
WD365MANDALA	141	WD408R	180	WD505	292	WD566COC	61	WD571DECV	240	WD608FAR	262	WD633SCO	67
WD365MANDARINO	138	WD408T	180	WD506AR	136	WD566CONI	58	WD571G	243	WD608FBE	262	WD633TOR	64
WD365MESSICO	141	WD408TR	180	WD506BL	136	WD566COR	57	WD571R	243	WD608FBL	262	WD634BEE	166
WD365N	139	WD408V	180	WD506CAL	136	WD566CUO	63	WD571V	243	WD608PAP	262	WD634GIN	166

CODICE	PAG.	CODICE	PAG.	CODICE	PAG.	CODICE	PAG.	CODICE	PAG.	CODICE	PAG.	CODICE	PAG.	CODICE	PAG.	CODICE	PAG.	CODICE	PAG.	CODICE	PAG.
WD634MAR	166	WD663AR	127	WD683B	31	WD706B	285	WD725V	106												
WD634MOJ	166	WD663BE	127	WD684AM	235	WD706G	285	WD726AR	108												
WD634SAN	166	WD663BL	127	WD684BL	235	WD706V	285	WD726BL	108												
WD634SPR	166	WD663V	127	WD684TR	235	WD707A	251	WD726GI	108												
WD635HAP	165	WD664AR	127	WD685AM	235	WD707B	251	WD726V	108												
WD636CAC	77	WD664BE	127	WD688L	235	WD707C	251	WD727BL	110												
WD636CAM	77	WD664BL	127	WD688TR	235	WD707D	251	WD727GI	110												
WD636GIR	77	WD664V	127	WD686CE	34	WD708B	197	WD728BL	111												
WD367	215	WD665AR	128	WD686GI	34	WD708N	197	WD728GI	111												
WD638	276	WD665BE	128	WD686R	34	WD709BL	49	WD729BL	112												
WD639	276	WD665BL	128	WD686TR	34	WD709G	49	WD729GI	112												
WD641	191	WD665V	128	WD687PET	35	WD709V	49	WD730	113												
WD643	275	WD666AR	130	WD687R	35	WD710COC	47	WD731	114												
WD644OLI	75	WD666BE	130	WD687RO	35	WD710CUO	47	WD732	117												
WD645PEP	74	WD666BL	130	WD687TR	35	WD710FAR	47	WD733	118												
WD646RO	155	WD666V	130	WD688BL	36	WD711AN	32	WD734	121												
WD647AZ	155	WD667AR	131	WD688R	36	WD711CR	32	WD735AZ	123												
WD648AR	155	WD667BE	131	WD688TR	36	WD711R	32	WD735B	123												
WD649G	156	WD667BL	131	WD688V	36	WD711V	32	WD735BE	123												
WD469PE	156	WD667V	131	WD689LI	38	WD716APE	42	WD735RO	123												
WD650V	156	WD669AR	132	WD689PE	38	WD716CON	42	WD736AR	5												
WD651	159	WD669BE	132	WD689R	38	WD717APE	44	WD737BO	6												
WD652AM	160	WD669BL	132	WD689TR	38	WD717COC	44	WD738LI	7												
WD652B	160	WD669V	132	WD690LI	39	WD717FAR	44	WD739AR	8												
WD652BL	160	WD670AR	133	WD690R	39	WD717LIB	44	WD740BO	9												
WD652G	160	WD670AZ	133	WD690TR	39	WD717LUM	44	WD740T	9												
WD653	161	WD670B	133	WD690V	39	WD717MAR	44	WD740V	9												
WD654	162	WD670BE	133	WD691PAPPA	21	WD718B	28	WD741AR	10												
WD655AM	163	WD670BL	133	WD691PAV	21	WD718R	28	WD741BO	10												
WD655BL	163	WD670M	133	WD692CIG	22	WD718RO	28	WD741LI	10												
WD655GI	163	WD670PET	133	WD692PAP	22	WD718V	28	WD742AR	13												
WD658AR	171	WD670V	133	WD693CAN	23	WD719B	29	WD742BO	13												
WD658AZ	171	WD671GIAZ	266	WD693PAG	23	WD719R	29	WD742LI	13												
WD658BL	171	WD671RME	266	WD694FEN	24	WD719RO	29	WD743AR	14												
WD658GI	171	WD671VAR	266	WD694GAL	24	WD719V	29	WD743LI	14												
WD659AR	172	WD672GIV	266	WD695AZZ	46	WD720CHE	17	WD743T	14												
WD659AZ	172	WD672RAZ	266	WD695ROS	46	WD720DRE	17	WD744AR													

NOTE - APPUNTI

A large grid of dots for taking notes, consisting of 20 columns and 25 rows of small, evenly spaced dots.

NOTE - APPUNTI

A large grid of dots for taking notes, consisting of 20 columns and 25 rows of small, evenly spaced dots.



www.wdlifestyle.it

Mercati srl - Via Dante 11
Levico Terme (TN) - ITALY
tel +39 0461 701179
info@wdlifestyle.it

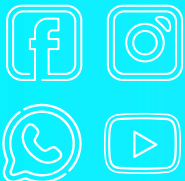

ST_12_2023

